







① Levostranné řízení

② Pravostranné řízení

-  Airbag
-  Plynový generátor
-  Předpínač bezpečnostních pásů
-  Plynová vzpěra / předepnutá pružina
-  Vyztužení struktury
-  Nízkonapěťový akumulátor
-  Benzín palivová nádrž

Oznámení: Další informace jsou uvedeny v naší [příručce pro záchranáře](#).



1. Identifikace / rozpoznávání

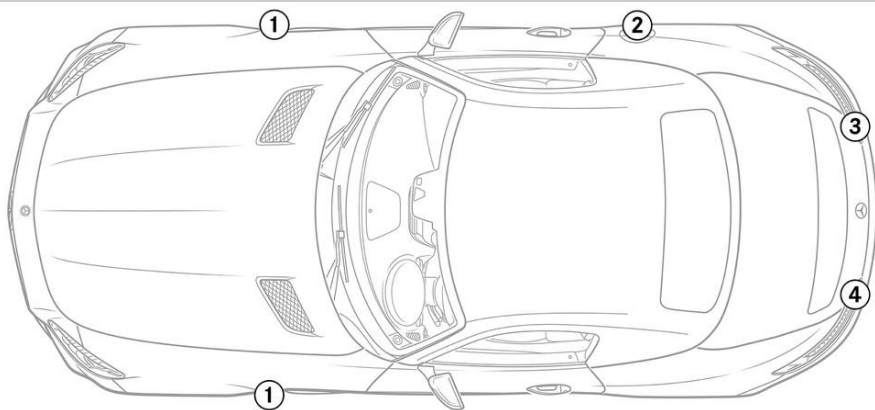

1

V8 BITURBO

2

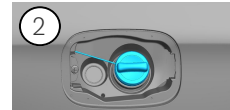

3

GT

4

