









-  Въздушна възглавница
-  Газов генератор
-  Устройство за предварително натягане на предпазния колан
-  Устройство за управление на допълнителната ограничителна система (SRS)
-  Активна с-ма за защита пешеходци
-  Пневмат.амортис. / Предвар.затегн.пружина
-  Нисковолт. акум. батер.
-  Бензин Резервоар гориво

Указание: Допълнителна информация можете да намерите в нашето [ръководство за спасяване](#).



1. Идентификация / разпознаване

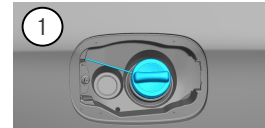
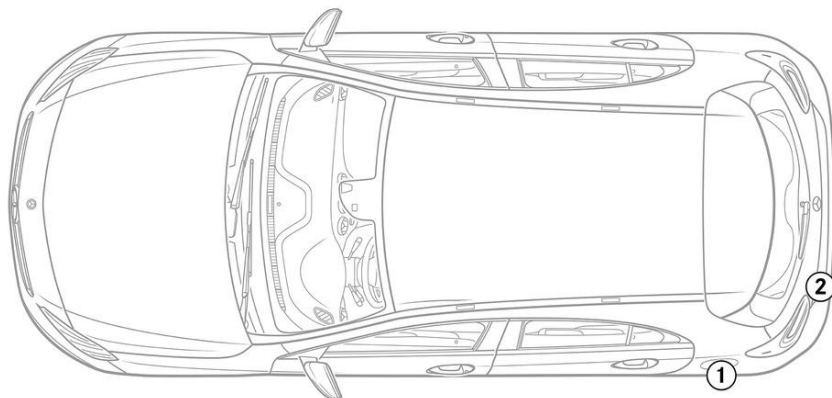

2  
**A160**