







-  에어백
-  가스 발전기
-  안전벨트 센서
-  SRS 컨트롤 유닛
-  가스 압력 댐퍼/프리텐션 스트링
-  저전압 배터리
-  디젤 연료 탱크

참고 사항: 자세한 내용은 [구조 안내서](#) 참조.



1. 식별/인식

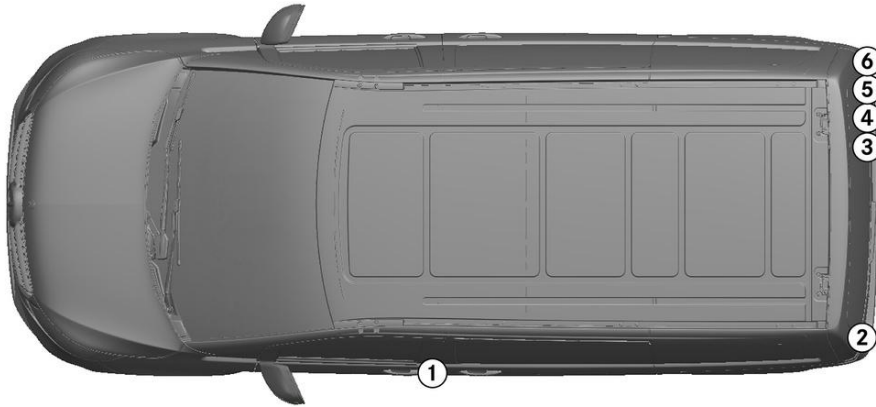

2

VITO TOURER

3

114 CDI

4

116 CDI

5

119 CDI

6

4x4

2. 고정/안정화/리프팅

주차 브레이크

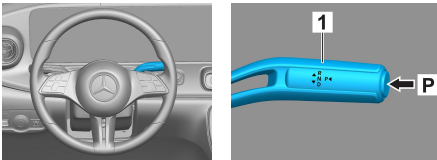

선택기 레버(1)의 스위치 P를 누르십시오.
주차 브레이크가 자동으로 활성화됩니다.

주차 브레이크

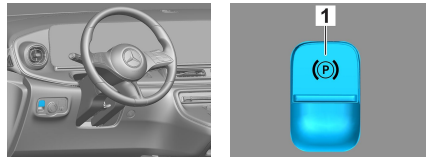

전자 주차 브레이크 (1)

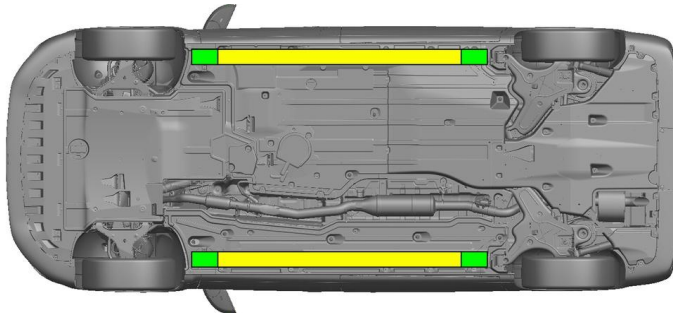

적합한 인양 지점

측면의 적합한 안정화 지점



구조하는 중 로커 패널과 언더바디의 추가적인 변형(예: 유압 장비로 지지)이 없도록 유의해야 합니다.

3. 직접적인 위험 제거/안전 규정 준수

점화 장치 끄기:

1. 주 브레이크를 밟지 않은 상태에서 START-STOP 버튼을 누르십시오.
2. 전자 차량 키를 5m 이상의 거리에 두십시오.

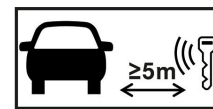

엔진 소음이 없다고 해서 차량이 꺼져 있는 것은 아닙니다.



차량이 종료될 때까지 재시동이 가능합니다.



12V 배터리 분리

1. 12V 배터리 커버 제거.
2. 12V 배터리의 음극 케이블을 볼트 체결부에서 푼 후 의도치 않게 접촉되지 않도록 보호하십시오.



수동 보안 시스템(에어백 및 안전벨트 텐서너)이 비활성화됩니다.



4. 요구조자(탑승자)에 접근

승객을 구조할 때 페이지 1의 정보에 따른 시트 안전 시스템의 부품(특히 폭발 요소)을 고려해야 합니다.

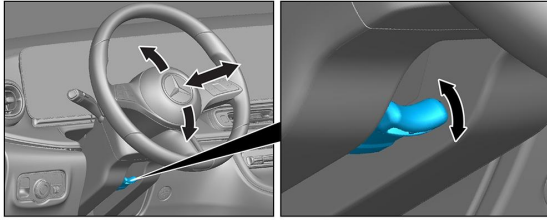

스티어링 휠 조정

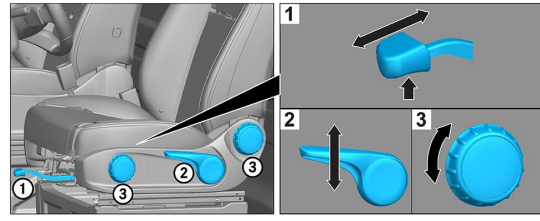

시트 조정(기계식)

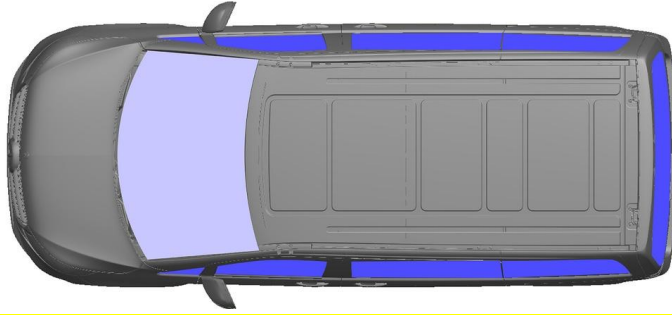

- VSG: 접합안전유리
- ESG: 강화 안전 유리

5. 저장된 에너지/액체/가스/고체

		12V
		57L
		600 ± 10g

6. 화재 시



차량 화재를 진압하려면 다량의 물(H₂O)을 사용하십시오.

7. 침수 시

차체에 전압이 남아 있을 위험이 없습니다. 차량 구조 후:

1. 내부의 물을 배출시키십시오.
2. 12V/48V 차량 전원 시스템의 비활성화를 시작하십시오(3장 참조).

8. 견인/운송/보관

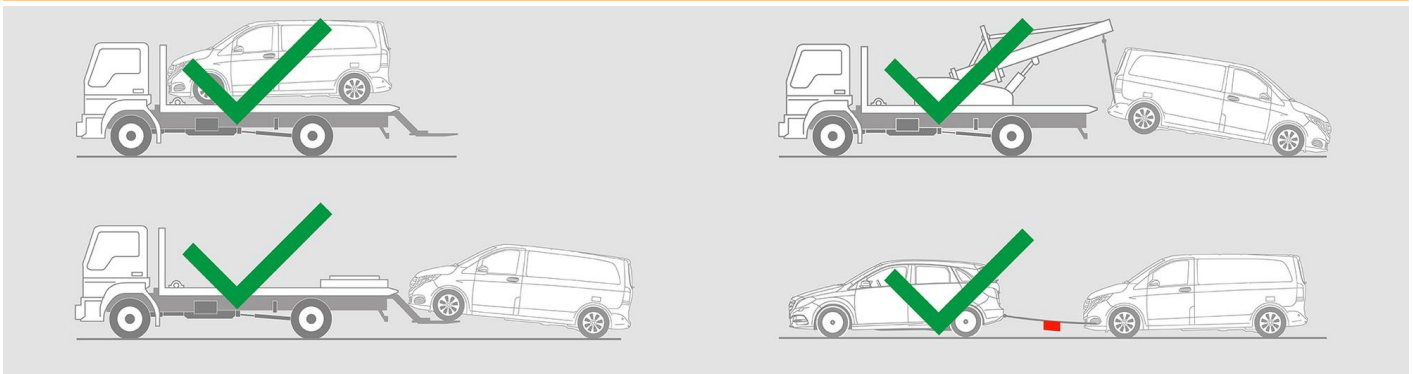

9. 중요 추가 정보

자세한 내용은 [견인 서비스 지침](#), [승용차](#) 에서 확인할 수 있습니다.



10. 사용된 픽토그램 설명



차량, 1급 액체 연료
주입



위험



가연성



건강에 위험



부식성



폭발성



물로 끄기



드라이폼으로 끄기



스마트 키 제거



Air-conditioning
component



Warning; low
temperature