







- |   |  |   |   |  |
|---|--|---|---|--|
|  Krockudde     |  Gasgenerator       |  Bältesförsträcker |  SRS styrenhet |  Gastrycksdämpare/förspänd fjäder |
|  Lågvoltbatteri |  Diesel bränsletank |   |   |  |

Observera: Mer information finns i vår [räddningsguide](#).



## 1. Identifiering

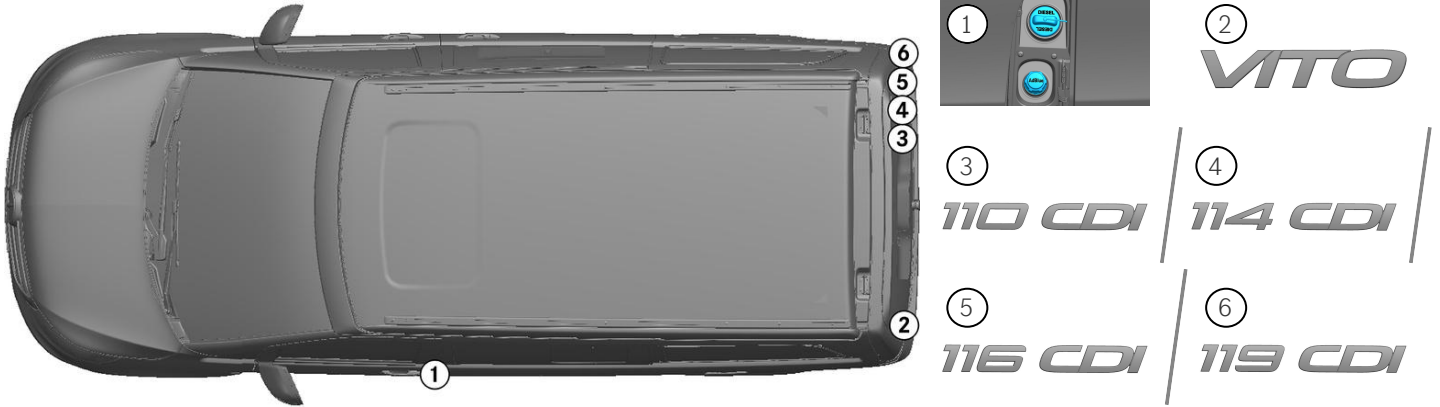

## 2. Immobilisering / stabilisering / lyft

### Parkeringsbroms

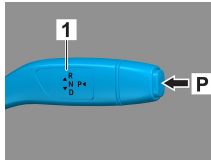

Tryck på strömbrytaren P på växelväljaren (1).  
Parkeringsbromsen aktiveras automatiskt.

### Parkeringsbroms

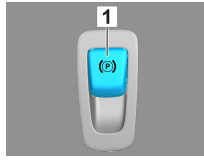

Elektrisk parkeringsbroms (1)

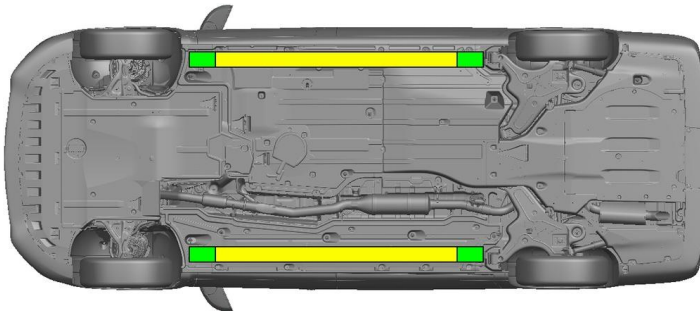

Lämpliga lyftpunkter



Lämpliga stabiliseringspunkter på sidan



Undvik att ytterligare deformera trösklarna och underredet under räddningsinsatsen (exempelvis genom att använda dem som stöd för hydraulisk utrustning).

## 3. Oskadliggöra akuta risker/ säkerhetsföreskrifter

### Slå av tändningen:

1. Tryck på START-STOP-knappen utan att manövrera färdbromsen.
2. Förvara den elektroniska fordonsnyckeln på minst 5 m avstånd.

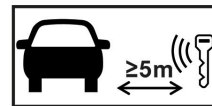

Frånvaron av motorljud är inget säkert tecken på att fordonet är avstängt.



Ny start kan ske tills fordonet har stängts av helt.



### Koppla loss 12-voltsbatteriet

1. Ta bort övertäckningen från 12-voltsbatteriet.
2. Lossa minuskabeln från skruvförbandet på 12-voltsbatteriet och säkra den mot oavsiktlig kontakt.



De passiva säkerhetssystemen (airbags och bältesförsträckare) inaktiveras.



#### 4. Åtkomst till passagerare

När personerna i bilen frigörs måste hänsyn tas till säkerhetssystemets komponenter (särskilt pyrotekniska element) i enlighet med informationen på sidan 1.

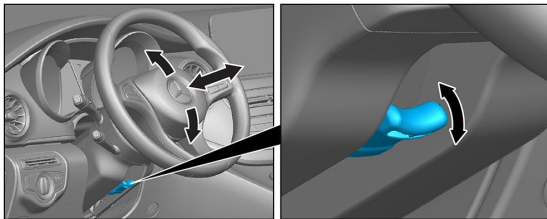

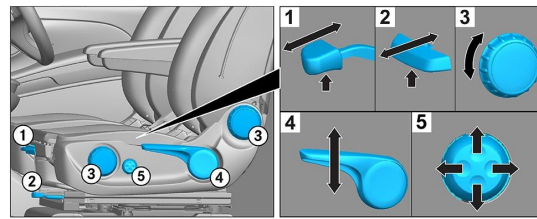

Rattinställning



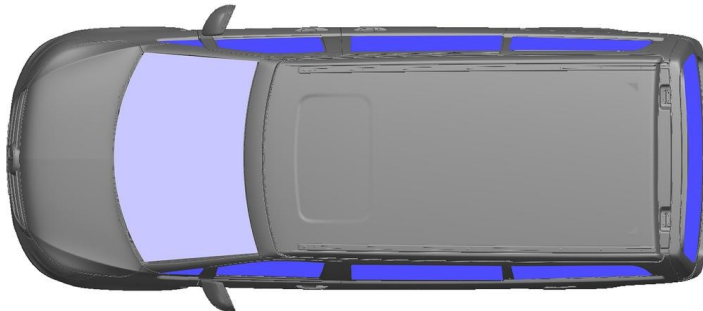



Stolsinställning (mekanisk)



 VSG: Laminerat säkerhetsglas  
 ESG: enkelt säkerhetsglas

#### 5. Lagrad energi / vätskor / gaser / fasta ämnen

	  	12V
	 	57L
	  	900 ± 10g

#### 6. I händelse av brand



Använd stora mängder vatten (H<sub>2</sub>O) vid släckning av fordonsbränder.

#### 7. Om fordonet är nedsänkt i vatten

Det finns ingen fara för att karossen är spänningssatt. Efter bärgning av fordonet:

1. Låt vattnet rinna ut ur kupén.
2. Inled inaktivering av elsystemet med 12/48 volt (se kapitel 3).

#### 8. Bogsering / transport / förvaring

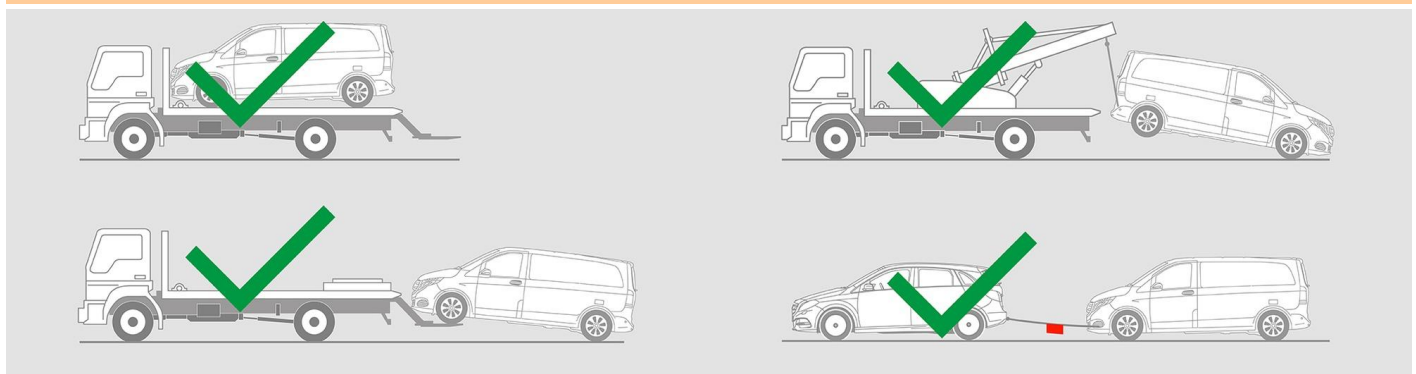



## 9. Övrig viktig information

Mer information finns i [Guide till personbilsbärgare](#).

## 10. Förklaring till de pictogram som används



Bränslefordon från  
vätskegrupp 1



Allmän varningsskylt



Brandfarligt



Farligt för människors  
hälsa



Frätande medel



Explosivt



Använd vatten för att  
släcka elden



Använd torrskum för  
att släcka elden



Ta bort smartnyckeln



Luftkonditioneringskom-  
ponent



Varning, låg temperatur