







- |                                                                                                       |                                                                                                           |                                                                                                   |                                                                                                      |                                                                                                                          |
|-------------------------------------------------------------------------------------------------------|-----------------------------------------------------------------------------------------------------------|---------------------------------------------------------------------------------------------------|------------------------------------------------------------------------------------------------------|--------------------------------------------------------------------------------------------------------------------------|
|  Airbag            |  Gasgenerator          |  Gordelspanner |  SRS regeleenheid |  Gasdrukdemper / voorgespannen veer |
|  Laagspannings-accu |  Diesel brandstof-tank |                                                                                                   |                                                                                                      |                                                                                                                          |

Let op: Meer informatie vindt u in onze [Leidraad voor hulpdiensten](#).



## 1. Identificatie / herkenning

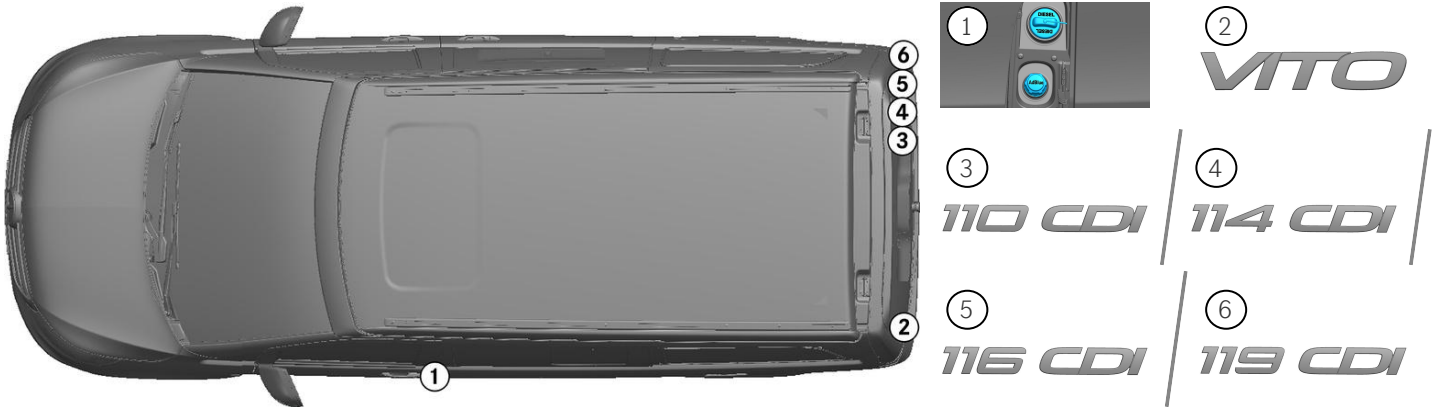

## 2. Immobilisatie / stabilisatie / heffen

### Parkeerrem

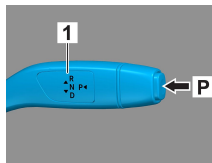

### Parkeerrem

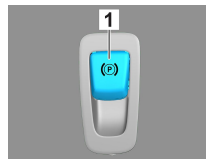

Schakelaar P aan de keuzehendel (1) indrukken.  
De parkeerrem wordt automatisch geactiveerd.

Elektrische parkeerrem (1)

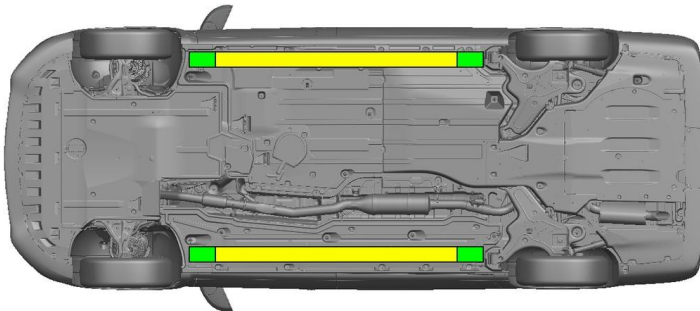

Geschikte krikpunten



Geschikte stabilisatiepunten aan de zijkant



Extra vervorming van de dorpels en de vloer tijdens de redding (bijv. door ondersteuning met hydraulische apparatuur) moet worden vermeden.

## 3. Directe gevaren uitschakelen / veiligheidsvoorschriften

### Contact uitschakelen:

1. START-STOP-knop indrukken zonder de bedrijfsrem te bedienen.
2. Elektronische sleutel van het voertuig op afstand van minstens 5 m bewaren.



De afwezigheid van motorgeluiden betekent niet dat het voertuig is uitgeschakeld.



Een herstart is mogelijk tot het voertuig buiten gebruik wordt gesteld.



### 12V-accu afklemmen

1. Afdekking van de 12V-accu verwijderen.
2. Minuskabel van de 12V-accu aan de schroefverbinding losmaken en deze beveiligen tegen onbedoeld contact.



De passieve veiligheidssystemen (airbags en gordelspanners) worden gedeactiveerd.



## 4. Toegang tot de inzittenden

Bij het bevrijden van de inzittenden moet rekening worden gehouden met de componenten van het veiligheidssysteem (in het bijzonder pyrotechnische elementen) conform de informatie op pagina 1.

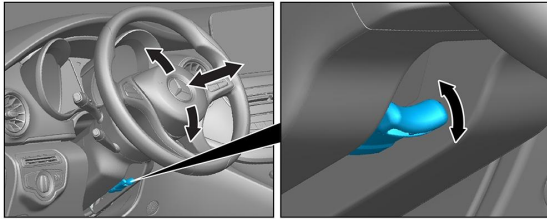

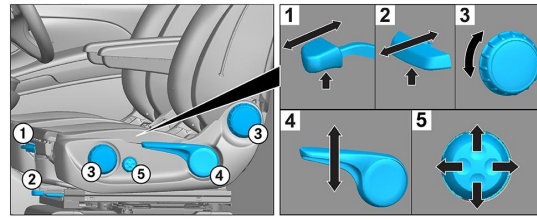

Stuurverstelling



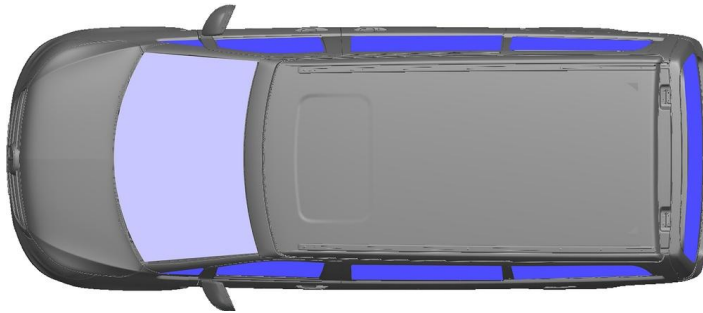





Stoelverstelling (mechanisch)



 VSG: Gelaagd veiligheidsglas  
 ESG: Enkelvoudig veiligheidsglas

## 5. Opgeslagen energie / vloeistoffen / gassen / vaste stoffen

	  	12V
	 	57L
	  	900 ± 10g

## 6. In geval van brand



Voor het blussen van een voertuigbrand grote hoeveelheden water (H<sub>2</sub>O) gebruiken.

## 7. In geval van onderdompeling

Er is geen gevaar dat er spanning op de carrosserie staat. Na de berging van het voertuig:

1. Het water uit het interieur laten lopen.
2. Deactiveren van het 12V/48V-boordnet starten (zie hoofdstuk 3).

## 8. Slepen / transport / opslag

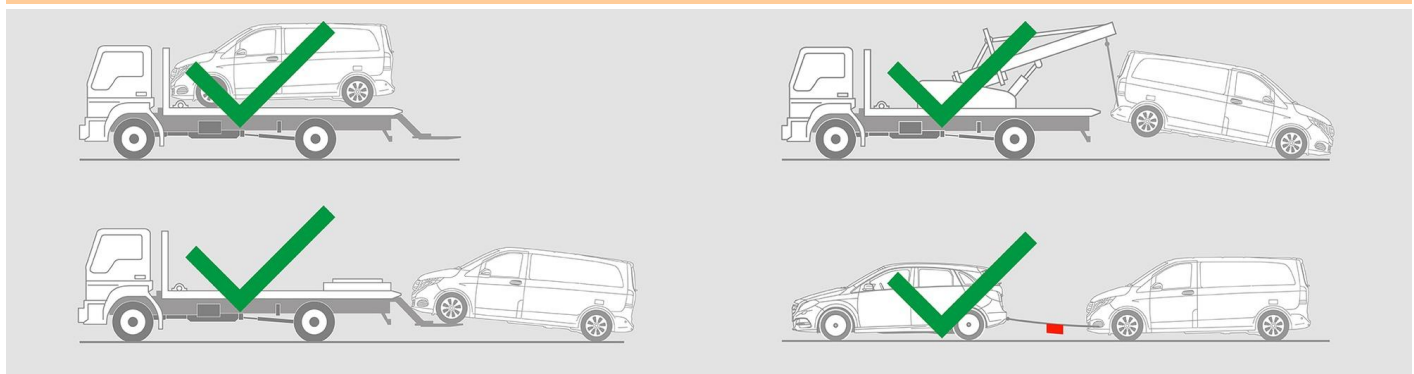



## 9. Belangrijke bijkomende informatie

Meer informatie vindt u in de [Leidraad voor sleepdiensten personenauto](#).

## 10. Verklaring van gebruikte pictogrammen



Voertuig op brandstof van vloeistofgroep 1



Algemeen waarschuwingsbord



Ontvlambaar



Gevaarlijk voor de menselijke gezondheid



Corrosief



Explosief



Gebruik water om het vuur te blussen



Gebruik droog schuim om het vuur te blussen



Slimme sleutel verwijderen



Airco-component



Waarschuwing; lage temperatuur