











-  Airbag
-  Gas generator
-  Seat belt pretensioner
-  SRS control unit
-  Gas strut / Pre-loaded spring
-  Low-voltage battery
-  Battery pack, High-voltage
-  High voltage power cable
-  High voltage component
-  Cable cut
-  Low voltage device that disconnects high voltage

Note: Please see our [emergency response guide](#) for more information



1. Identification / recognition

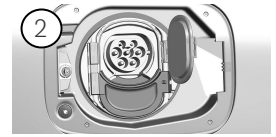
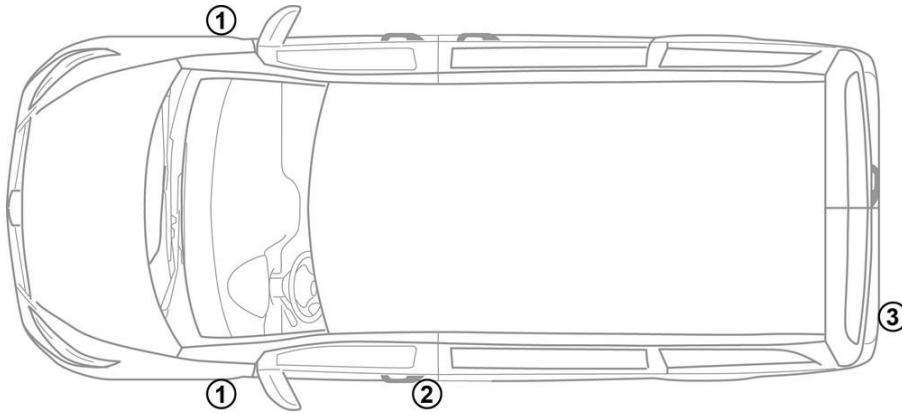

3. Disable direct hazards / safety regulations

Deactivation of the high-voltage system

In all other cases, the high-voltage system should be deactivated as follows:

Option 1: High-voltage disconnect

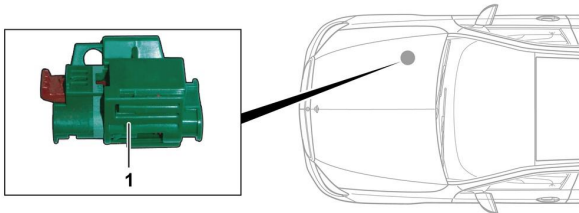

The high-voltage disconnect is located in the engine compartment on the passenger side.

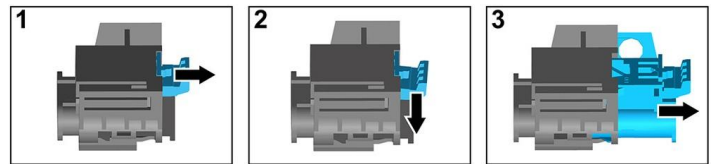

- (1) Pull the release
- (2) Push the release down
- (3) Pull out the switch



Option 2: Alternative high-voltage disconnect

The alternative high-voltage disconnect is located in the base of the right-hand front seat. It is indicated with a sign.



Remove the cover (1). Cut the cable at the marked point (2).



Disconnecting the 12 V battery

1. Remove the cover from the 12-volt battery.
2. Disconnect the negative cable of the 12-volt battery at the screw connection and secure it against unintentional contact.