











-  Airbag
-  Gas generator
-  Seat belt pretensioner
-  SRS control unit
-  Gas strut / Pre-loaded spring
-  Low-voltage battery
-  Battery pack, High-voltage
-  High voltage power cable
-  High voltage component
-  Cable cut
-  Low voltage device that disconnects high voltage

Note: Please see our [emergency response guide](#) for more information



1. Identification / recognition

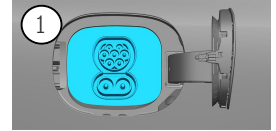
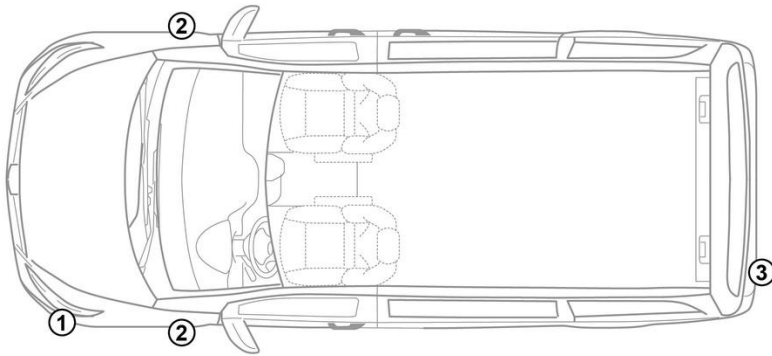

2. Immobilisation / stabilisation / lifting

Parking brake – One of the following variants is installed, depending on the vehicle type:



- 1. Move the selector lever to position P.
- 2. Move the selector lever to position N.

Parking brake – One of the following variants is installed, depending on the vehicle type:

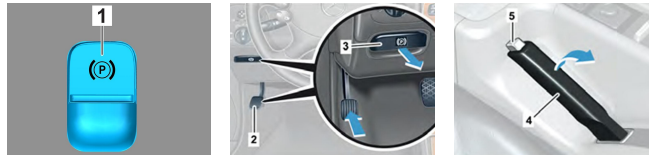

- 1. Electric parking brake
- 2. Parking brake pedal
- 3. Release the parking brake button
- 4. Parking brake lever
- 5. Release the parking brake lever button

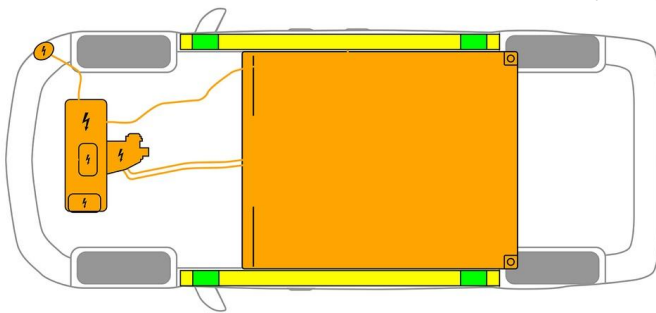

- Suitable lifting points
- Suitable stabilisation points on the side
- High-voltage battery

Additional deformation of the door sills and the underbody (e.g. through support with hydraulic equipment) must be avoided during the rescue.

3. Disable direct hazards / safety regulations

Switch off the ignition:

- 1. Turn the ignition key anti-clockwise in the ignition lock and remove it from the ignition lock.
- 2. Remove the ignition key from the vehicle.

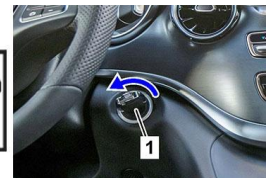

The absence of engine noise does not mean that the vehicle is switched off.

A restart is possible until the vehicle is switched off.

Deactivation of the high-voltage system

The high-voltage system is automatically switched off in the event of accidents in which the airbags and seat belt pretensioners trigger.





In all other cases, the high-voltage system should be deactivated as follows:



### Option 1: High-voltage disconnect

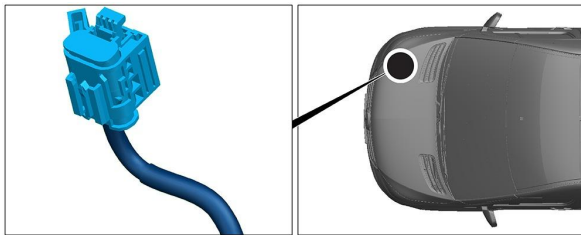

The high-voltage disconnect is located in the engine compartment on the passenger side.



- (1) Pull the release
- (2) Push the release down
- (3) Pull out the switch



### Option 2: Alternative high-voltage disconnect

The alternative high-voltage disconnect is located in the base of the right-hand front seat. It is indicated with a sign.



Remove the cover (1). Cut the cable at the marked point (2).



In order to ensure that there is no longer any residual voltage in the high-voltage system, wait approx. 20 seconds after switching it off.



The passive safety systems such as airbags and seat belt pretensioners will continue to be supplied with power by the 12-volt electrical system.



### Disconnecting the 12 V battery

1. Remove the cover from the 12-volt battery.
2. Disconnect the negative cable of the 12-volt battery at the screw connection and secure it against unintentional contact.



The passive safety systems (airbags and seat belt pretensioners) are deactivated.

#### 4. Access to the occupants

When rescuing the vehicle occupants, the components of the restraint systems (in particular pyrotechnic elements) must be taken into account in accordance with the information on page 1.





Steering wheel adjustment

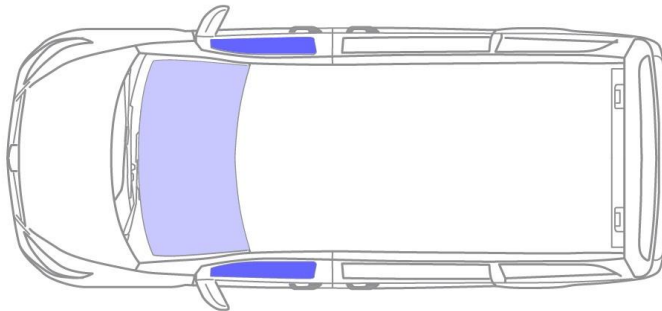

Seat adjustment (mechanical)



 VSG: Laminated safety glass  
 ESG: Tempered glass

#### 5. Stored energy / liquids / gases / solids



 All high-voltage cables have orange insulation.

#### 6. In case of fire

 Use large volumes of water (H<sub>2</sub>O) to extinguish a vehicle fire.  
Use large volumes of water (H<sub>2</sub>O) to cool the Li-ion battery.

 Warning: Battery re-ignition



 If coolant is leaking from the high-voltage battery, it may become unstable owing to thermal overload. Check the battery temperature with an IR thermal imager.



#### 7. In case of submersion

There is no risk of voltage in the bodywork.

After recovery of the vehicle:

1. Allow the water to drain out of the interior.
2. Commence deactivation of the high-voltage system (see Section 3).



### 8. Towing / transportation / storage

Only transport the vehicle with both axles on a tow truck or car transporter.

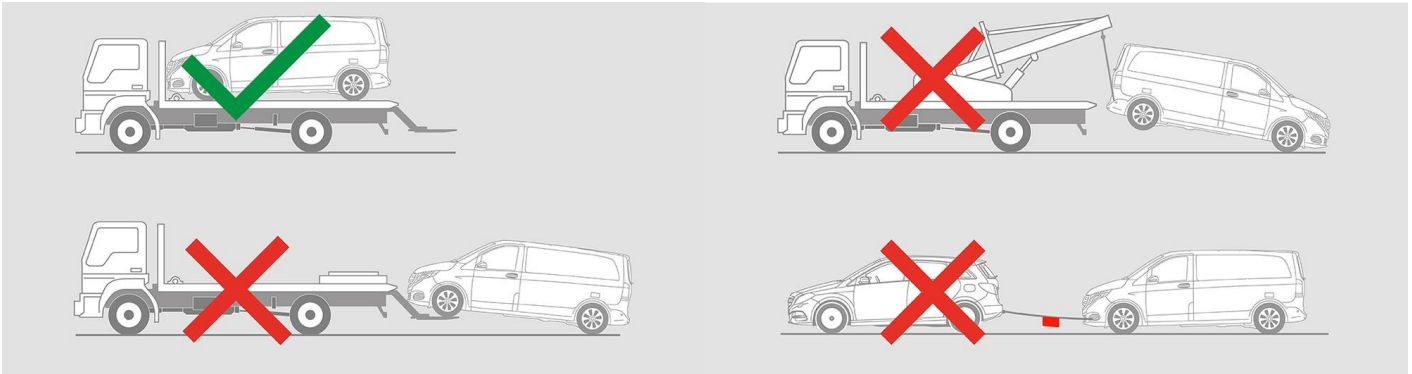











Maintain a safe distance from other vehicles.

Warning: Battery re-ignition

### 9. Important additional information

You can find more information in the [Guidelines for car towing services](#).

### 10. Explanation of pictograms used

- |   |                               |   |                      |   |                      |   |                                  |
|---|-------------------------------|---|----------------------|---|----------------------|---|----------------------------------|
|   | Electric Vehicle              |  | General warning sign |  | Warning, Electricity |  | Flammable                        |
|  | Hazardous to the human health |  | Corrosives           |  | Acute toxicity       |  | Use water to extinguish the fire |
|  | Use thermal Infrared camera   |  | Bonnet               |  | Remove smart key     |   |                                  |