







-  에어백
-  가스 발전기
-  안전벨트 텐서  
너
-  SRS 컨트롤 유  
닛
-  가스 압력 댐  
퍼/프리텐션 스  
프링
-  저전압 배터리
-  디젤 연료 탱크

참고 사항: 자세한 내용은 [구조 안내서](#) 참조.



### 1. 식별/ 인식

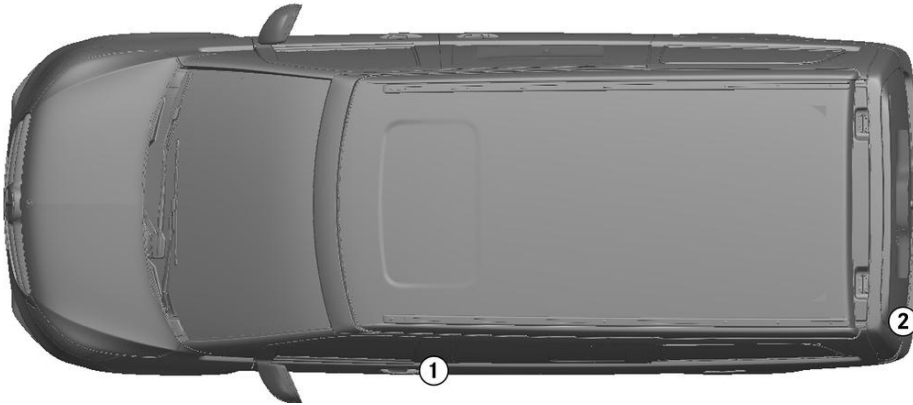

### 2. 고정 / 안정화 / 리프팅

#### 주차 브레이크

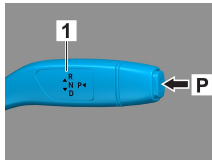

#### 주차 브레이크

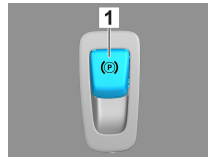

선택기 레버(1)의 스위치 P를 누르십시오.  
주차 브레이크가 자동으로 활성화됩니다.

전자 주차 브레이크 (1)

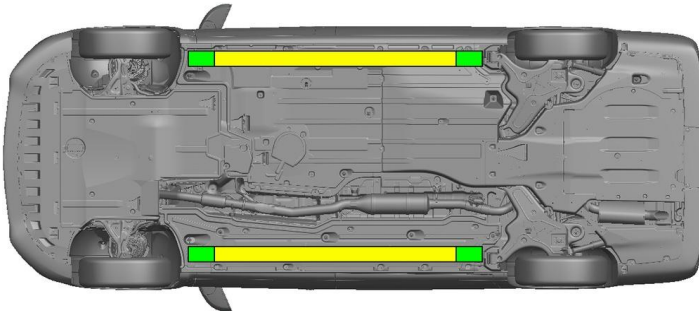

- 적합한 인양 지점
- 측면의 적합한 안정화 지점



구조하는 중 로커 패널과 언더바디의 추가적인 변형(예: 유압 장비로 지지)이 없도록 유의해야 합니다.

### 3. 직접적인 위험 제거 / 안전 규정 준수

#### 점화 장치 끄기:

- 주 브레이크를 밟지 않은 상태에서 START-STOP 버튼을 누르십시오.
- 전자 차량 키를 5m 이상의 거리에 두십시오.



엔진 소음이 없다고 해서 차량이 꺼져 있는 것은 아닙니다.



차량이 종료될 때까지 재시동이 가능합니다.



#### 12V 배터리 분리

- 12V 배터리 커버 제거.
- 12V 배터리의 음극 케이블을 볼트 체결부에서 푼 후 의도치 않게 접촉되지 않도록 보호하십시오.



수동 보안 시스템(에어백 및 안전벨트 텐서너)이 비활성화됩니다.



#### 4. 요구조자(탑승자)에 접근

승객을 구조할 때 페이지 1의 정보에 따른 시트 안전 시스템의 부품(특히 폭발 요소)을 고려해야 합니다.

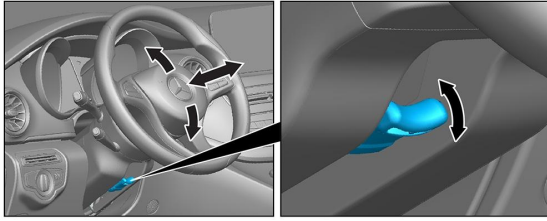

스티어링 휠 조정

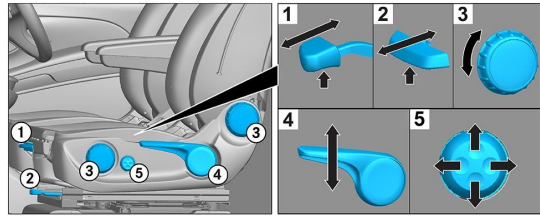

시트 조정(기계식)

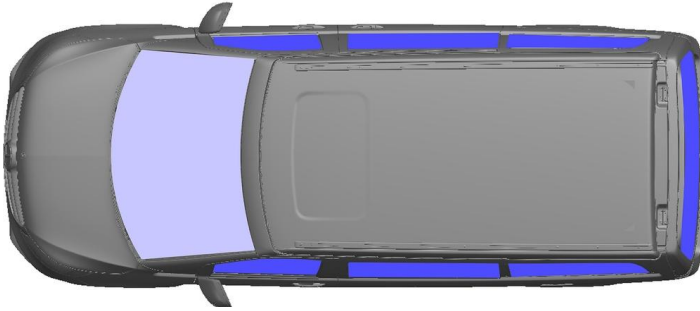

VSG: 접합안전유리  
ESG: 강화 안전 유리

#### 5. 저장된 에너지/액체/가스/고체

		12V
		57L
		900 ± 10g

#### 6. 화재 시



차량 화재를 진압하려면 다량의 물(H<sub>2</sub>O)을 사용하십시오.

#### 7. 침수 시

차체에 전압이 남아 있을 위험이 없습니다. 차량 구조 후:

1. 내부의 물을 배출시키십시오.
2. 12V/48V 차량 전원 시스템의 비활성화를 시작하십시오(3장 참조).

#### 8. 견인/운송/보관

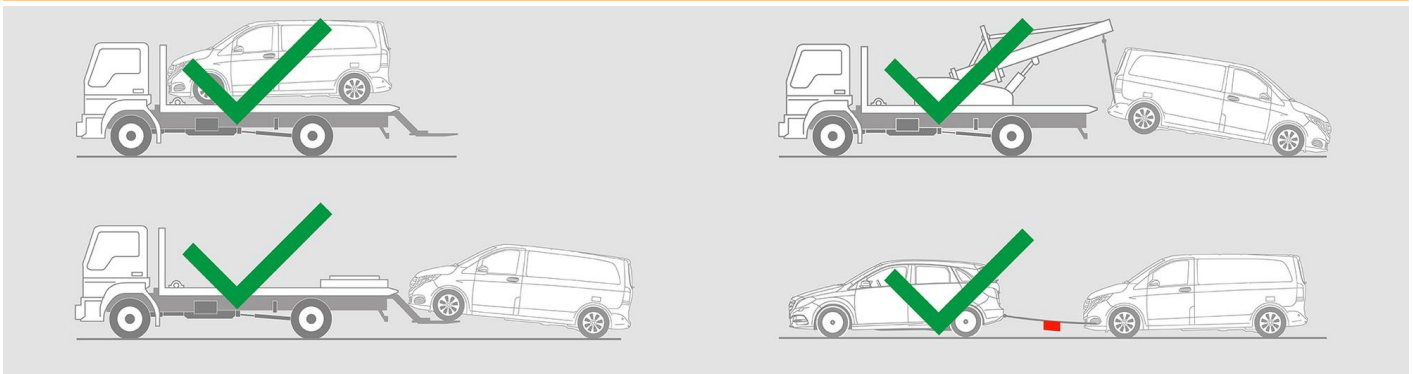

#### 9. 중요 추가 정보

자세한 내용은 [견인 서비스 지침](#), [승용차](#) 에서 확인할 수 있습니다.



10. 사용된 픽토그램 설명



차량, 1급 액체 연료  
주입



위험



가연성



건강에 위험



부식성



폭발성



물로 끄기



드라이폼으로 끄기



스마트 키 제거



Air-conditioning  
component



Warning; low  
temperature