

- | | | | | | | | | | |
|--|-------------------------------|--|--------------------|--|---------------------|--|-----------------------|--|---|
| | Hava yastığı | | Gaz jeneratörü | | Kemer gerdiriciler | | SRS kumanda kutusu | | Gaz basınçlı amortisör/Ön gerilimli yay |
| | Dikkat gerektiren bölge | | Alçak voltajlı akü | | Yüksek voltajlı akü | | Yüksek voltaj kablosu | | Yüksek voltaj bileşeni |
| | Yüksek gerilim ayırma noktası | | | | | | | | |

Not: Daha fazla bilgi için lütfen [Kurtarma Kılavuzu](#)'muza bakınız.

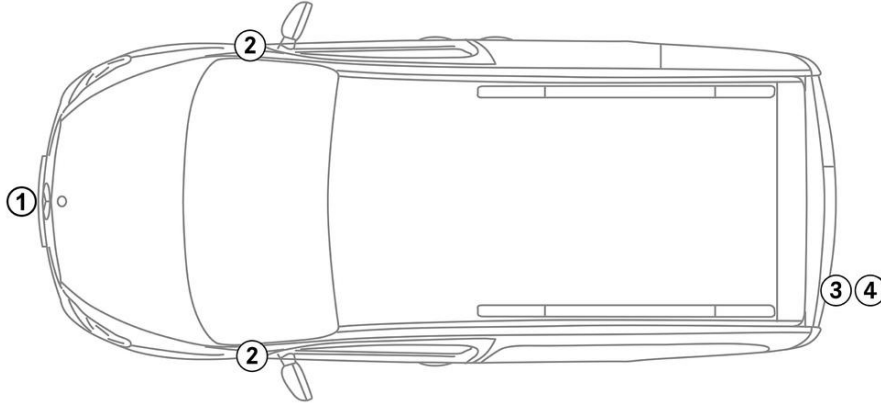

1. Araç tanımı / tanımlama



2

ELECTRIC

3 EQT

4

eCITAN

2. İşletimden alma / stabilizasyon / kaldırma

Park freni



Sabitleştirici fren

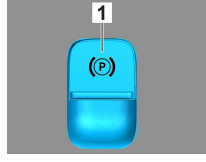

Vites seçme kolunu (1) P konumuna getirin. Park freni otomatik olarak etkinleştirilir. Elektrikli sabitleştirici fren (1)

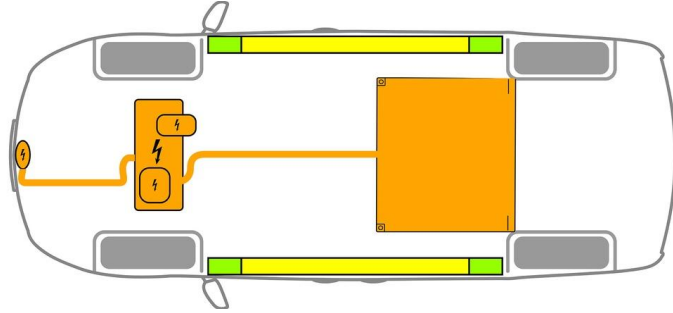

- Uygun kaldırma noktaları
- Yanda bulunan uygun stabilizasyon noktaları
- Yüksek gerilimli akü



Kurtarma sırasında eşiklerin ve gövde altının ek deformasyonunun (örneğin hidrolik ekipmanla desteklenerek) önüne geçilmesi gerekir.

3. Doğrudan tehlikelerin ortadan kaldırılması / güvenlik düzenlemeleri

Main Method

Kontakın kapatılması:

- İşletim frenini etkinleştirmeden BAŞLAT-DURDUR (START-STOP) tuşuna basın.
- Elektronik araç anahtarını en az 5 m mesafede tutun.

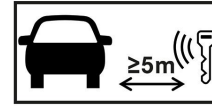

Motor sesinin duyulmaması aracın kapatılmış olduğu anlamına gelmez.



Araç işletim dışı bırakılana kadar yeniden çalıştırma olanaklıdır.

Yüksek gerilim sisteminin etkinliğinin kaldırılması



Hava yastıklarının ve emniyet kemeri gerdiricilerinin açıldığı bir kaza durumunda, yüksek gerilim sistemi otomatik olarak kapatılır.





Alternative Method

Diğer tüm durumlarda, yüksek gerilim sistemi aşağıdaki şekilde devre dışı bırakılmalıdır:



Yüksek gerilim kapatma düzeneği

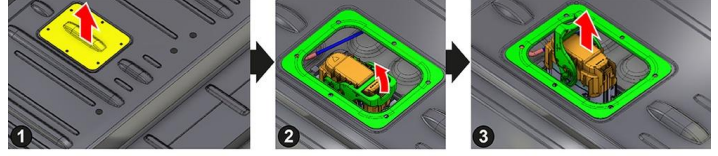
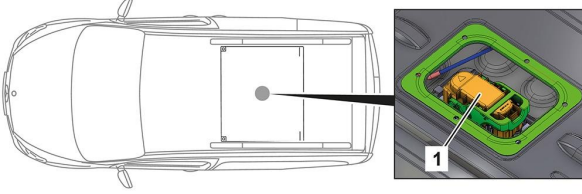

Yüksek voltaj kapatma tertibatı motor odasında sürücü tarafında bulunur. Arka koltuk sırasını öne itin ve kaldırın. Yüksek voltaj kapatma tertibatı, iç bölmede yüksek voltajlı akünün üst kısmındadır.

- (1) Koruyucu başlığı ve kapatma kapağını çıkartın
- (2) Fişin kilidini açın
- (3) Fişi çıkartın



Yüksek gerilim şebekesinde artık gerilim kalmadığından emin olmak için, kapattıktan sonra yakl. 20 saniye bekleyin.



Hava yastıkları ve emniyet kemeri gerdiricileri gibi pasif güvenlik sistemlerine 12 Volt araç elektrik sisteminden gerilim beslemesi yapılmasına devam edilir.

Access



12 V akünün ayrılması



1. Motor bölümünde bulunan 12 Volt akünün kapağını çıkartın.
2. 12 Volt akünün eksi kablosunu vidalı bağlantıdan sökün ve yanlışlıkla temasa karşı emniyete alın.



Hava yastıkları ve emniyet kemeri gerdiricileri gibi pasif güvenlik sistemleri devre dışı bırakılmıştır.

4. Araç yolcularına erişim

Yolcuları kurtarıırken emniyet sistemi bileşenleri (özellikle piroteknik elemanlar) sayfa 1'deki bilgilere göre dikkate alınmalıdır.

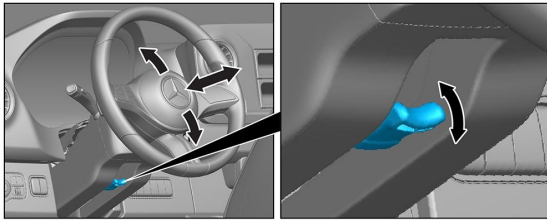

Direksiyon simidi ayarı

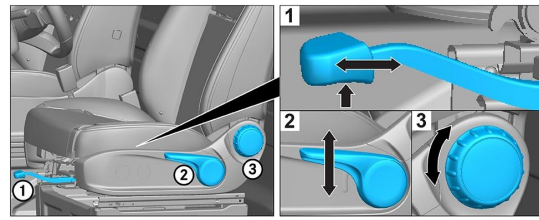

Koltuk ayarı (mekanik)

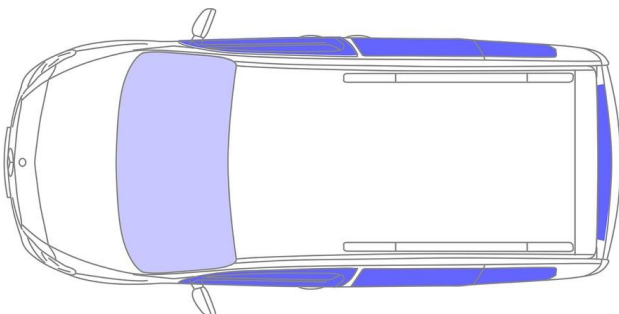

VSG: Lamine emniyet camı



ESG: Temperli emniyet camı



5. Depolanmış enerji / sıvılar / gazlar / katı maddeler



Tüm yüksek gerilim hatları turuncu renkli bir yalıtıma sahiptir.

6. Araç yangını



Fireman Access behind the second row of seats.

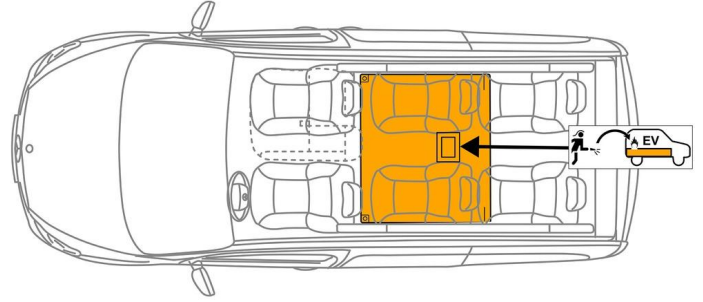

Bir araç yangınına söndürmek için bol miktarda su (H₂O) kullanın.

Lityum iyon aküyü soğutmak için bol miktarda su (H₂O) kullanın.



Uyarı: Akünün tekrar ateşlenmesi



Yüksek gerilimli aküden soğutucu maddenin sızması halinde, akü, termal aşırı yük nedeniyle kararsız hale gelebilir. Akü sıcaklığını bir IR termal görüntüleme kamerası ile kontrol edin.



7. Suda bulunan araçlar

Karoside gerilim olması halinde tehlike mevcut değildir.

Araç kurtarmanın ardından:

1. İç mekândaki suyun akarak boşalmasını bekleyin.
2. Yüksek gerilim sisteminin devre dışı bırakılmasını başlatın (bkz. Bölüm 3).

8. Çekme / nakliye / depolama

Araçın nakliyesini, sadece her iki aksı bir çekici veya araç taşıyıcı üzerindeyken gerçekleştirin.

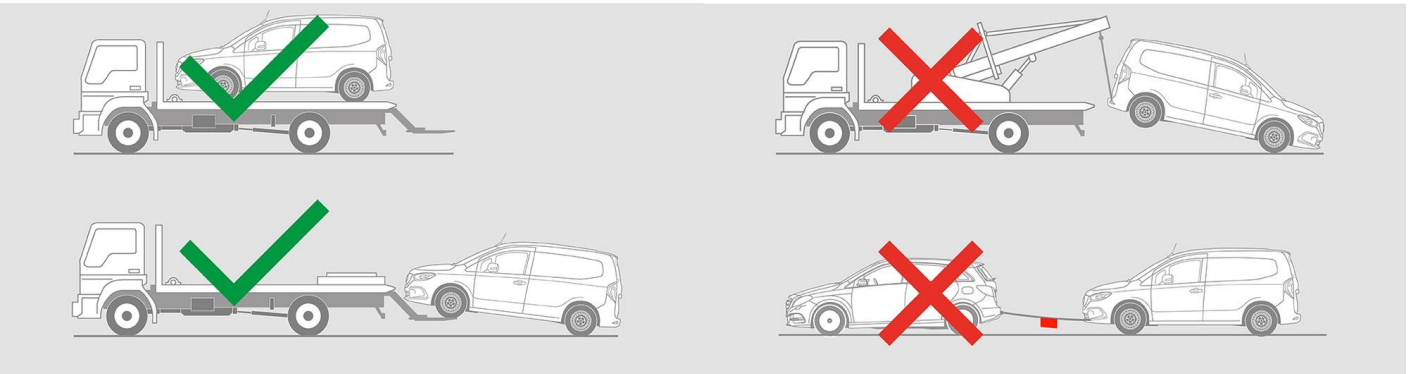

Diğer araçlarla emniyet mesafesini muhafaza edin.



Uyarı: Akünün tekrar ateşlenmesi



9. Önemli ek bilgiler

Daha fazla bilgiyi [Binek otomobili araç çekme hizmetleri için kılavuz](#) da bulabilirsiniz.



10. Kullanılan piktogramların açıklaması



Elektrikli araç



Tehlike



Gerilim tehlikesi



Tutuşabilir



Sağlığa zararlı



Korozif



Akut toksisite



Su ile söndürülmesi



Safety gloves



Face shield



IR termal kamerayı kullanın



Motor kaputu



Smart anahtarını çıkartın



Special battery access