











-  Airbag
-  Gasgenerator
-  Forspænder til sikkerhedssele
-  SRS kontrolenhed
-  Gastryksdæmper/forspændt fjeder
-  Forsigtighedszone
-  Lavspændingsbatteri
-  Batteripakke, højspænding
-  Højspændingskabel
-  Højspændingskomponent
-  Højspændingsenhed, der afbryder højspænding

Bemærkning: For yderligere oplysninger henvises til vores [redningsvejledning](#).



### 1. Identifikation / genkendelse

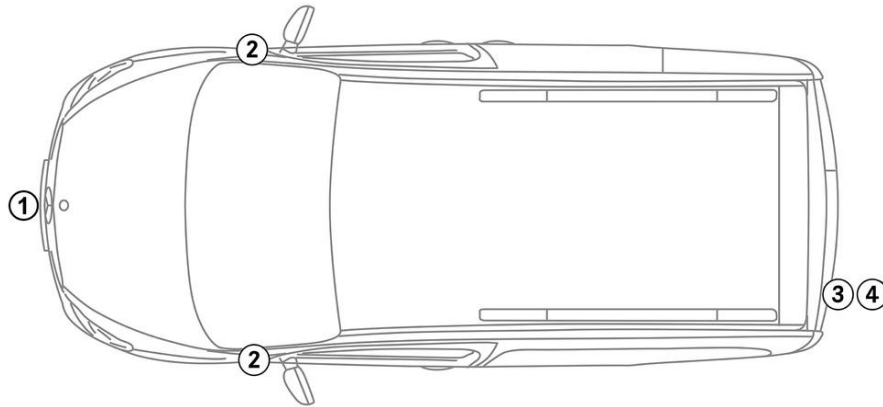

2

ELECTRIC

3 EQT

4

eCITAN

### 2. Immobilisering / Stablisering / Løft

#### Parkeringsbremse



#### Håndbremse

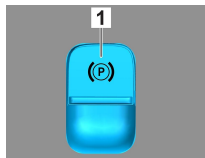

Sæt gearvælger (1) i position P. Parkeringsbremsen aktiveres automatisk. Elektrisk håndbremse (1)

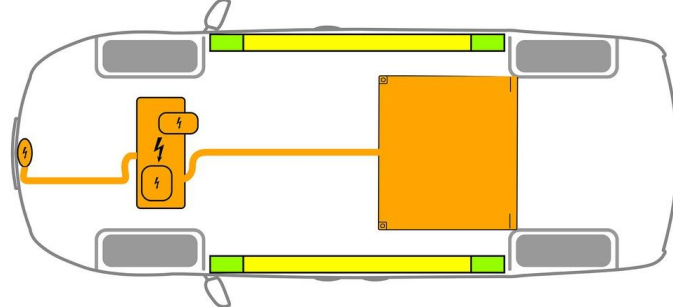

- Egnede løftepunkter
- Egnede stabiliseringspunkter på siden
- Højvoltsbatteri



Yderligere deformation af karmer og undervogn under bjærgningen (f.eks. ved afstivning med hydraulisk udstyr) skal undgås.

### 3. Deaktivering særlige farer / sikkerhedsforskrifter

#### Main Method

#### Slå tændingen fra:

- Tryk på START-STOP-knappen uden at aktivere driftsbremsen.
- Hold den elektroniske køretøjsnøgle i en afstand på mindst 5 m.

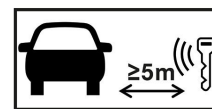

Fraværet af motorlyde betyder ikke, at køretøjet er slukket.



En genstart er mulig, indtil køretøjet tages ud af drift.

#### Deaktivering af højvoltssystemet



I tilfælde af ulykker, hvor airbags og forspændere til sikkerhedssele udløses, slås højvoltssystemet automatisk fra.





### Alternative Method

I alle andre tilfælde skal højvoltage systemet deaktiveres på følgende måde:



#### Højvoltsafbryder

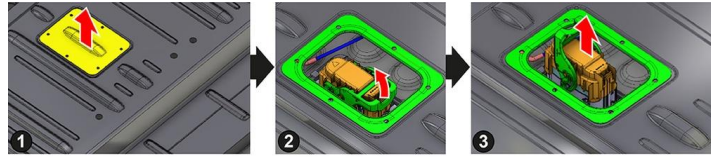
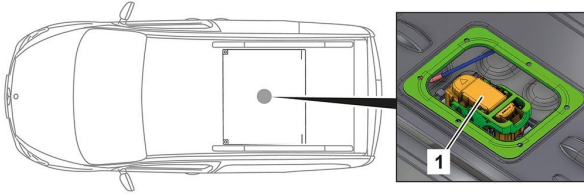

Højvolt-afkoblingsenheden er placeret i motorrummet i førersiden.

Skub det bageste bænk sæde fremad, og løft det.

Højvolt-afkoblingsenheden er placeret i kabinen på oversiden af højvoltage batteriet.

(1) Fjern beskyttelsesklappe og dækkappe

(2) Frigør stikket

(3) Træk stikket ud



For at sikre, at der ikke er restspænding i højspændingsnettet, skal du vente cirka 20 sekunder efter afbrydelsen.



De passive sikkerhedssystemer såsom airbags og forspændere til sikkerhedssele forsynes fortsat med strøm fra 12-voltsledningsnettet.

### Access



#### Afbryd 12 V-batteriet



1. Fjern dækslet til 12-voltsbatteriet i motorrum.

2. Løsn minuskablet på 12-voltsbatteriet ved skrueforbindelsen, og sikr det mod utilsigtet kontakt.



De passive sikkerhedssystemer (airbags og forspændere til sikkerhedssele) deaktiveres.

## 4. Adgangveje til tilskadekommande

Ved frigørelse af personer i bilen skal der tages hensyn til komponenterne i sikkerhedssystemerne (især pyrotekniske elementer) i overensstemmelse med angivelserne på side 1.

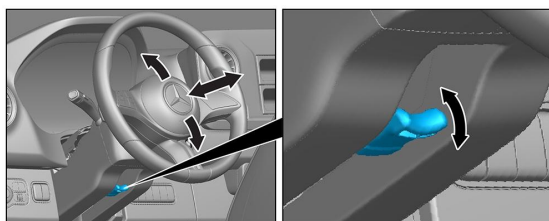

Ratindstilling

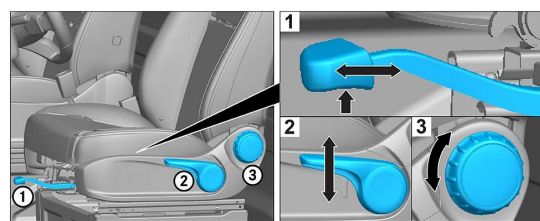

Sædeindstilling (mekanisk)

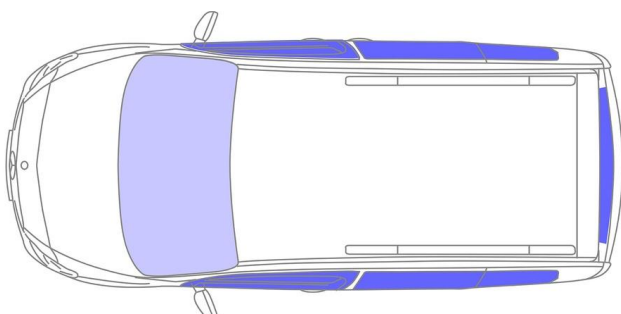

- VSG: lamineret sikkerhedsglas
- ESG: hærdet glas



## 5. Oplagret energi / væsker / gasser / faste stoffer



Alle højvoltsledninger er forsynet med en orangefarvet isolering.

## 6. I tilfælde af brand



Fireman Access behind the second row of seats.



Brug store mængder vand (H<sub>2</sub>O), når en køretøjsbrand skal slukkes.  
Brug store mængder vand (H<sub>2</sub>O) til at afkøle li-ion-batteriet.

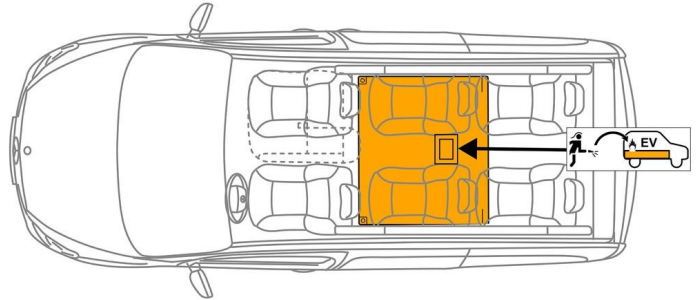

Advarsel: Genantændelse af batteriet



Hvis kølemiddel lækker fra højvoltsbatteriet, kan det blive ustabil på grund af termisk overbelastning. Kontrollér batteriets temperatur med et IR-varmefølsomt kamera.



## 7. I vand

Der er ingen fare ved, at der er spænding på karrosseriet.

Efter bjærgning af køretøjet:

1. Lad vandet løbe ud af kabinen.
2. Påbegynd deaktivering af højvoltssystemet (se kapitel 3).

## 8. Bugsering / transport / opbevaring

Transportér kun køretøjet med begge hjulsæt på et bugseringskøretøj eller en autotransporter.

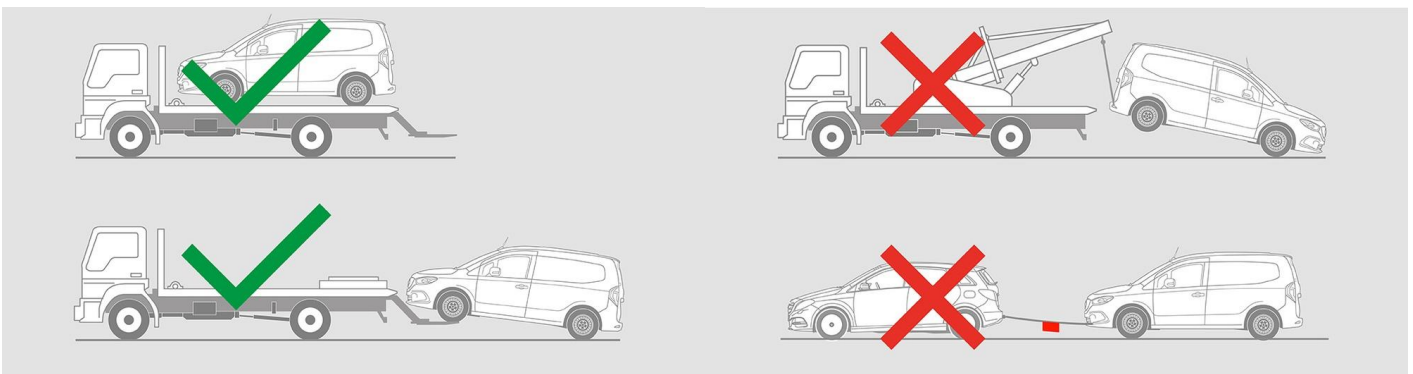

Opbevaring i sikker afstand af andre køretøjer.



Advarsel: Genantændelse af batteriet



## 9. Vigtige ekstra oplysninger

Yderligere oplysninger findes i [Vejledning for bjærgningsfirmaer, personvogne](#).



10. Piktogram information



Elektrisk køretøj



Generelt advarsels-  
skilt



Advarsel, elektricitet



Brandfarligt



Farligt for menneskers  
sundhed



Ætsende



Akut toksicitet



Brug vand til at slukke  
ilden



Safety gloves



Face shield



Brug termisk infrarødt  
kamera



Motorhjeml



Fjern smart nøgle



Speciel batteriadgang