









- | | | | | | | | | | |
|---|--------------------------------|---|-------------------|---|--------------------|--|---------------------|---|----------------------------------|
|  | Turvatyyny |  | Kaasugeneraattori |  | Turvavyön kiristin |  | SRS-ohjainlaite |  | Kaasujousi / esijännitetty jousi |
|  | Huomioalue |  | Matalajänniteakku |  | Korkeajänniteakku |  | Korkeajännitejohdot |  | Korkeajännite Komponentit |
|  | Korkeajännitteen katkaisukohta | | | | | | | | |

Ohje: Katso lisätietoja [pelastusohjeestamme](#).



1. Ajoneuvon tunnistaminen/ identifiointi

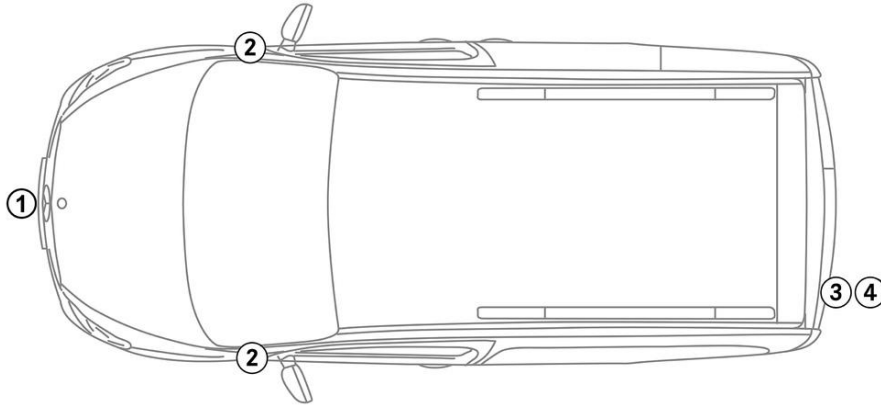

②

ELECTRIC

③ EQT

④

eCITAN

2. Ajoneuvon sammuttaminen / stabilointi

Seisontajarru



1. Paina vaihteenvaihtin asentoon P.

Seisontajarru

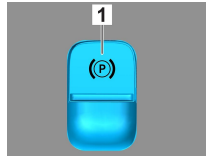

1. Sähköinen seisontajarru

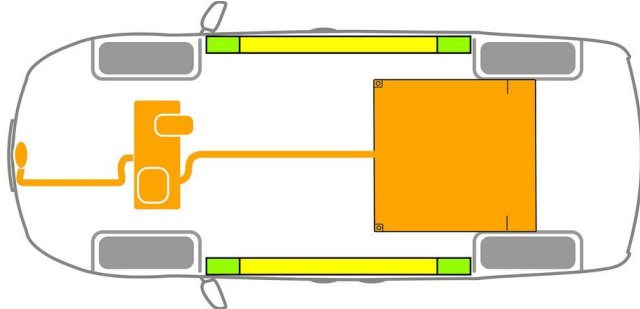

Soveltuvat nostopisteet



Soveltuvat vakautuspisteet sivulla



Korkeajänniteakku



Kynnyksen ja pohjan lisävääntymisen pelastuksen aikana (esim. tuenta hydraulikkavarusteilla) on vältettävä.

3. Ajoneuvon vaarattomaksi tekeminen

Main Method

Kytke sytytysvirta pois päältä:

1. Paina START-STOP-painiketta painamatta käyttöjarrua.
2. Säilytä ajoneuvon sähköinen avain vähintään 5 metrin etäisyydellä.

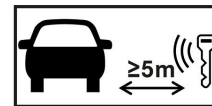

Moottorin äänien puuttuminen ei tarkoita, että ajoneuvo on kytketty pois päältä.



Uudelleenkäynnistys on mahdollista ajoneuvon käytöstäpoistamiseen asti.

Korkeajännitejärjestelmän deaktivointi



Korkeajännitejärjestelmä kytketään automaattisesti pois päältä sellaisten onnettomuuksien tapauksessa, joissa turvatyyny ja turvavyönkiristimet laukeavat.



A 000 817 90 06



Alternative Method

Kaikissa muissa tapauksissa korkeajännitejärjestelmä on deaktivoitava seuraavasti:



Korkeajännitteen poiskytkentälaitte

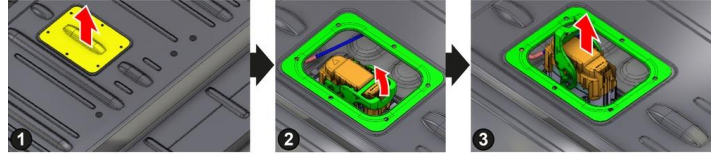
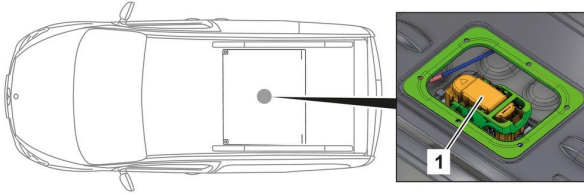

Korkeajännite-poiskytkentälaitte on moottoritilassa kuljettajan puolella. Työnnä takaistuinpennkkiä eteenpäin ja nosta.

Korkeajännite-poiskytkentälaitte on sisätilassa korkeajänniteakun yläosassa.

- (1) Poista suojalevy ja peitelevy
- (2) Avaa pistokkeen lukitus
- (3) Vedä pistoke ulos



Odota poiskytkennän jälkeen n. 20 sekuntia sen varmistamiseksi, ettei korkeajänniteverkossa ole enää jäännösjännitystä.



Ajoneuvon 12 V:n sähköverkko syöttää edelleen virtaa passiivisille turvajärjestelmille, kuten turvatyynyille ja turvavyönkiristimille.

Access



12 V:n akun kytkeminen irti

1. Poista 12 V:n akun suojus moottoritilasta.
2. Irrota 12 V:n akun miinusjohto ruuviliitännästä ja varmista tahattoman kosketuksen estämiseksi.



Passiiviset turvajärjestelmät (turvatyynyt ja turvavyönkiristimet) deaktivoidaan.

4. Ajoneuvon sisällä olevien pelastaminen

Vapautettaessa autossa matkustavia henkilöitä on huomioitava turvavarusteiden komponentit (erityisesti pyrotekniset elementit) sivulla 1 olevien tietojen mukaisesti.

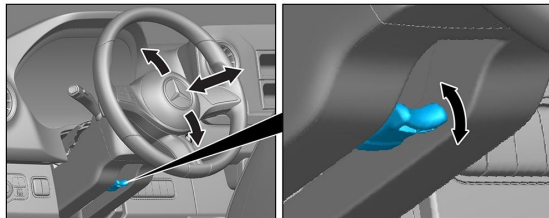

Ohjauspyörän säätö

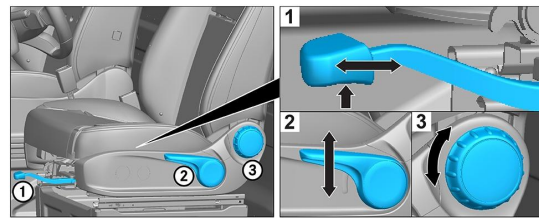

Istuimen säätö (mekaaninen)

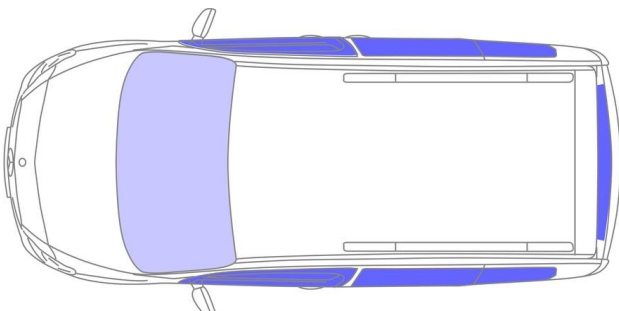

- VSG: Laminoitu varmuuslasi
- ESG: Karkaistu varmuuslasi



5. Ajoneuvon käyttövoima, nesteet, kiinteät aineet



Kaikki korkeajännitejohdot on varustettu oranssilla eristyksellä.

6. Toimenpiteet tulipalon sattuessa



Fireman Access is in the second row of seats under the bench seat.



Käytä ajoneuvopalon sammuttamiseen suuria määriä vettä (H₂O).

Käytä litiumioniakun jäädyttämiseen suuria määriä vettä (H₂O).

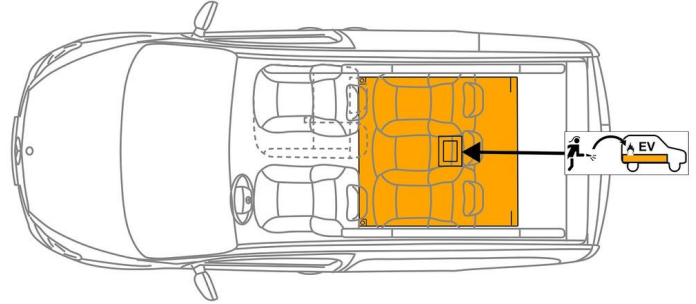

Varoitus: Akun uudelleensyttyminen



Jos korkeajänniteakusta tulee ulos jäähdytysainetta, siitä voi tulla termisen ylikuormituksen vuoksi epävaka. Tarkasta akun lämpötila ip-lämpökamera.



7. Toimenpiteet auton joutuessa hukuksiin

Ei ole vaaraa, että korissa olisi jännite.

Ajoneuvon pelastamisen jälkeen:

1. Anna veden virrata pois sisätilasta.
2. Deaktivoi korkeajännitejärjestelmä (katso luku 3).

8. Hinaaminen / Kuljetus / Varastointi

Kuljeta ajoneuvoa vain molemmat akselit hinausautossa tai autonkuljetusautossa.

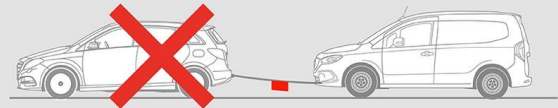
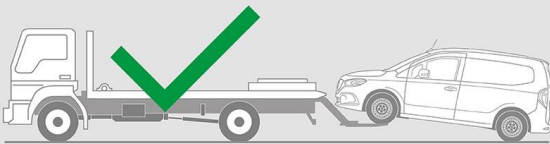
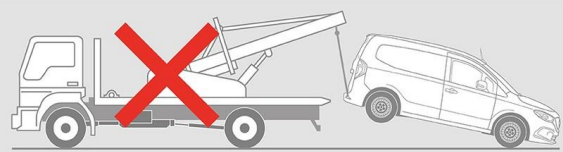
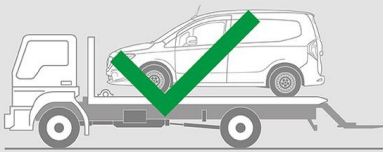

Säilytä turvallisen etäisyyden päässä muista ajoneuvoista.



Varoitus: Akun uudelleensyttyminen



9. Tärkeitä lisätietoja

Lisätietoja on kohdassa [Ohjeet henkilöautojen hinauspalveluille](#).



10. Merkkien selitykset



Sähköauto



Vaara



Jännitevaara



Syttyvä



Terveydelle haitallinen



Syövyttävä



Välitön myrkyllisyys



Sammuta vedellä



Safety gloves



Face shield



Käytä IR-
lämpökameraa



Konepelti



Smart-avaimen
poistaminen



Special battery access