











-  Airbag
-  Gas generator
-  Seat belt pretensioner
-  SRS control unit
-  Gas strut / Pre-loaded spring
-  Warning zone
-  Low-voltage battery
-  Battery pack, High-voltage
-  High voltage power cable
-  High voltage component
-  High voltage device that disconnects high voltage

Note: Please see our [emergency response guide](#) for more information



1. Identification / recognition

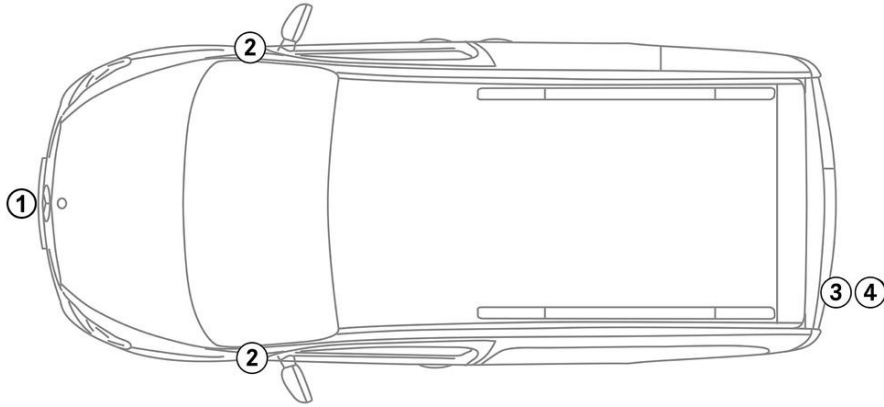

2. Immobilisation / stabilisation / lifting

Parking brake



1. Move the selector lever to position P.

Parking brake

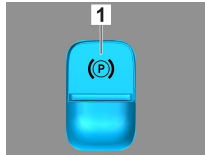

1. Electric parking brake

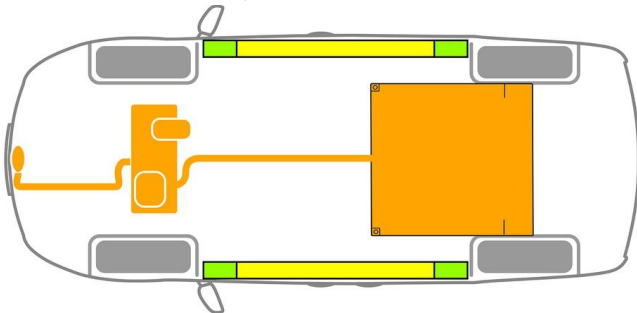

- Suitable lifting points
- Suitable stabilisation points on the side
- High-voltage battery

Additional deformation of the door sills and the underbody (e.g. through support with hydraulic equipment) must be avoided during the rescue.

3. Disable direct hazards / safety regulations

Main Method

Switch off the ignition:

1. Press the START/STOP button without actuating the service brake.
2. Keep the electronic vehicle key at a distance of at least 5 m.

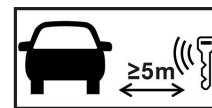

The absence of engine noise does not mean that the vehicle is switched off.

A restart is possible until the vehicle is switched off.

Deactivation of the high-voltage system

The high-voltage system is automatically switched off in the event of accidents in which the airbags and seat belt pretensioners trigger.





Alternative Method

In all other cases, the high-voltage system should be deactivated as follows:



High-voltage disconnect

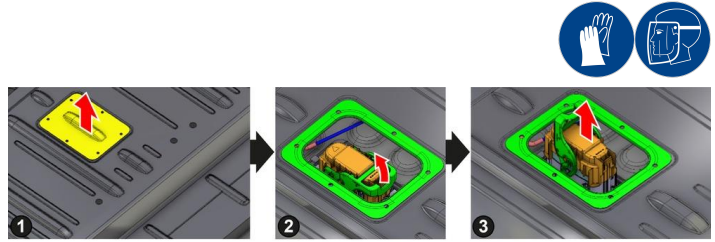
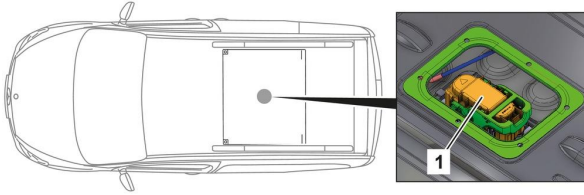

Push rear bench seat forward and lift. The high-voltage disconnect device is located in the interior at the top of the high-voltage battery.

- (1) Remove dust cap and cover cap
- (2) Pull the release
- (3) Pull out the switch



In order to ensure that there is no longer any residual voltage in the high-voltage system, wait approx. 20 seconds after switching it off.



The passive safety systems such as airbags and seat belt pretensioners will continue to be supplied with power by the 12-volt electrical system.

Access



Disconnecting the 12 V battery



- 1. Remove the cover from the 12-volt battery in the engine compartment.
- 2. Disconnect the negative cable of the 12-volt battery at the screw connection and secure it against unintentional contact.



The passive safety systems (airbags and seat belt pretensioners) are deactivated.

4. Access to the occupants

When rescuing the vehicle occupants, the components of the restraint systems (in particular pyrotechnic elements) must be taken into account in accordance with the information on page 1.

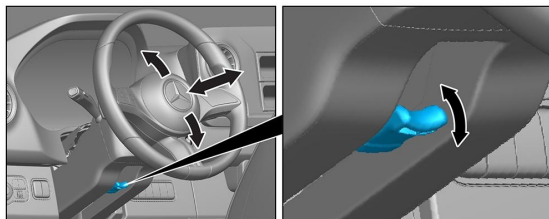

Steering wheel adjustment

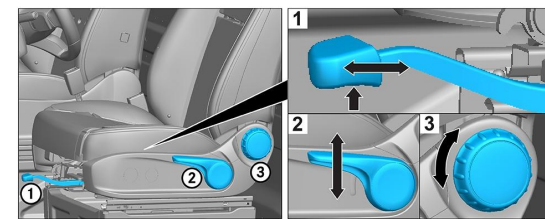

Seat adjustment (mechanical)

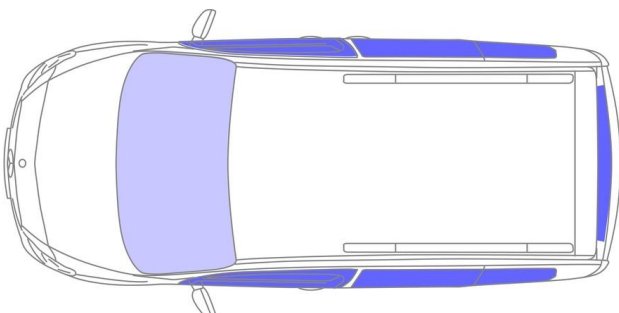

- VSG: Laminated safety glass
- ESG: Tempered glass



5. Stored energy / liquids / gases / solids



All high-voltage cables have orange insulation.

6. In case of fire



Fireman Access is in the second row of seats under the bench seat.



Use large volumes of water (H₂O) to extinguish a vehicle fire.
Use large volumes of water (H₂O) to cool the Li-ion battery.

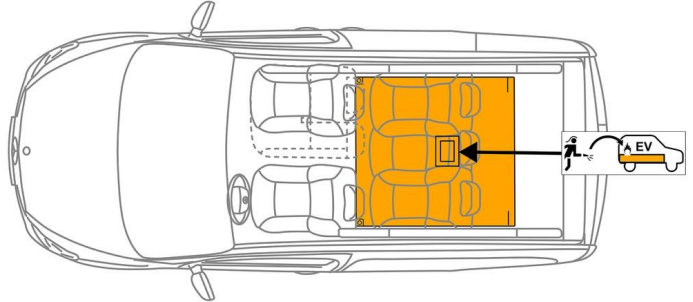

Warning: Battery re-ignition



If coolant is leaking from the high-voltage battery, it may become unstable owing to thermal overload. Check the battery temperature with an IR thermal imager.



7. In case of submersion

There is no risk of voltage in the bodywork.

After recovery of the vehicle:

1. Allow the water to drain out of the interior.
2. Commence deactivation of the high-voltage system (see Section 3).

8. Towing / transportation / storage

Only transport the vehicle with both axles on a tow truck or car transporter.

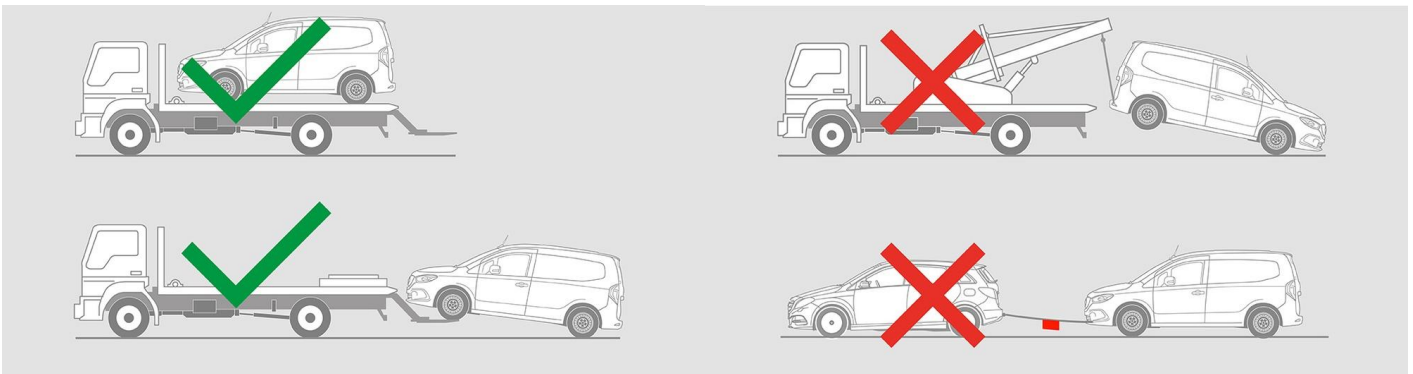

Maintain a safe distance from other vehicles.



Warning: Battery re-ignition



9. Important additional information

You can find more information in the [Guidelines for car towing services](#).



10. Explanation of pictograms used



Electric Vehicle



General warning sign



Warning, Electricity



Flammable



Hazardous to the human health



Corrosives



Acute toxicity



Use water to extinguish the fire



Safety gloves



Face shield



Use thermal Infrared camera



Bonnet



Remove smart key



Special battery access