







-  Zračni meh
-  Plinski generator
-  Zateznik varnostnega pasu
-  Krmilna enota za pomožni omejevalni sistem SRS
-  Plinski blažilnik/prednapeta vzmet
-  Območje prevodnosti
-  Nizkovoltni akumulator
-  Baterijski sklop, visokonapetostni
-  Visokonapetostni električni kabel
-  Komponenta za visoko napetost
-  Visokonapetostna naprava, ki izklopi visoko napetost

Napotek: Za več informacij si oglejte naš [reševalni vodnik](#).



### 1. Identifikacija / prepoznavanje

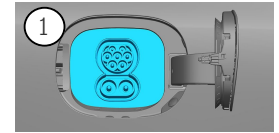
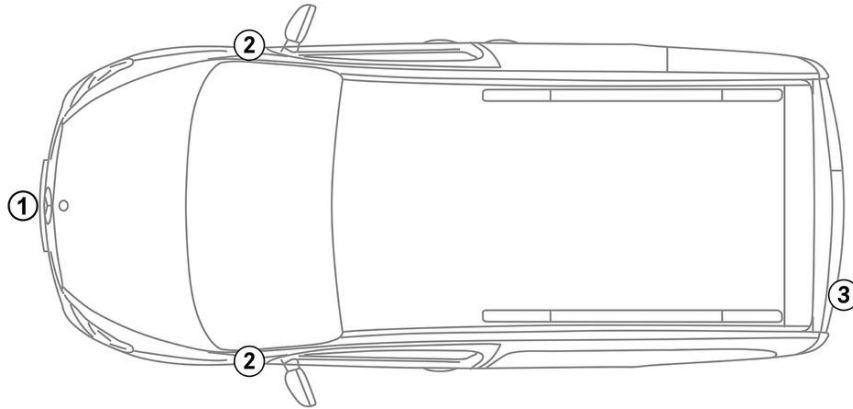

### 2. Imobilizacija / stabilizacija / dvig

#### Ročna zavora



1. Izbirno ročico pritisnite v položaj P.

#### Parkirna zavora

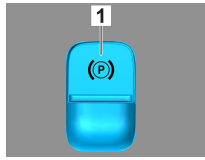

1. Električna parkirna zavora

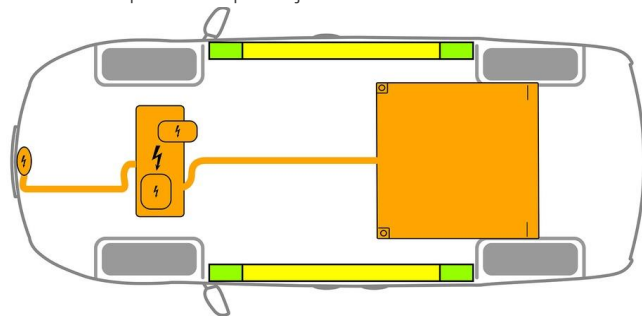

- Ustrezne dvizne točke
- Ustrezne stabilizacijske točke na strani
- Visokonapetostni akumulator



Preprečiti je treba dodatne deformacije pragov in podvozja med reševanjem (npr. s podporo s hidravlično opremo).

### 3. Onemogočanje neposrednih nevarnosti / varnostni predpisi

#### Izklop vžiga:

1. Pritisnite tipko START-STOP brez aktiviranja delovne zavore.
2. Elektronski ključ vozila hranite na razdalji najmanj 5 m.

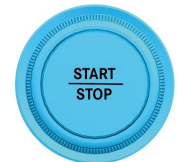
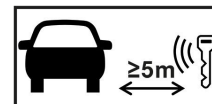

Odsotnost hrupa motorja ne pomeni, da je vozilo izklopljeno.



Ponovni zagon je možen, dokler vozilo ne preneha delovati.

#### Deaktiviranje visokonapetostnega sistema



V primeru nesreče, v kateri se sprožijo zračne blazine in zategovalniki varnostnega pasu, se visokonapetostni sistem samodejno izklopi.





V vseh drugih primerih je treba visokonapetostni sistem deaktivirati na naslednji način:



### Možnost 1: Visokonapetostna odklopna naprava

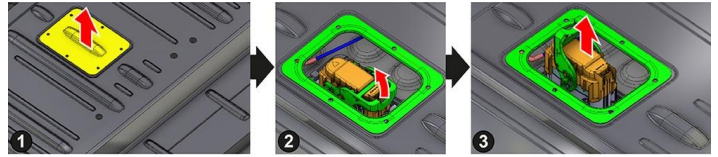
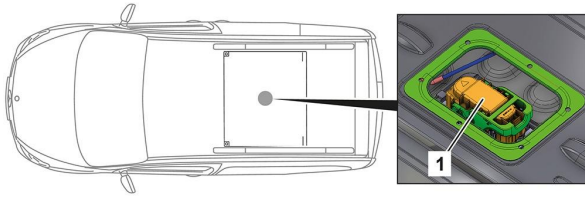

Visokovoltna izklopna naprava je v motornem prostoru na voznikovi strani. Zadnje sedežno klop potisnite naprej in jo dvignite.

- (1) Odstranite zaščitni pokrovček in prekrivno kapico
- (2) Sprostite vtič
- (3) Izvlecite vtič

Visokovoltna izklopna naprava je nameščena v notranjosti na zgornji strani visokovoltnega akumulatorja.



Da zagotovite, da v visokonapetostnem omrežju ni preostale napetosti, po izklopu počakajte približno 20 sekund.



Pasivne varnostne sisteme, kot so zračne blazine in zategovalnik varnostnega pasu, še naprej napaja 12-voltni električni sistem vozila.



### Odklop 12-V akumulatorja



1. Odstranite pokrov 12-V akumulatorja v prostoru za motor.
2. Odvijte negativni kabel 12-V akumulatorja na vijačnem priključku in ga zavarujte pred nenamernim stikom.



Pasivni varnostni sistemi (zračne blazine in zategovalniki varnostnega pasu) se deaktivirajo.

## 4. Dostop do potnikov

Pri reševanju potnikov upoštevajte komponente zadrževalnih sistemov (posebno pirotehnične elemente) v skladu s podatki na 1. strani.

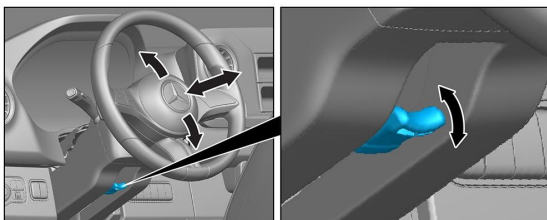

Nastavitev volana

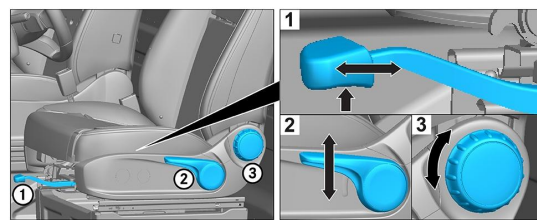

Nastavitev sedeža (mehanska)

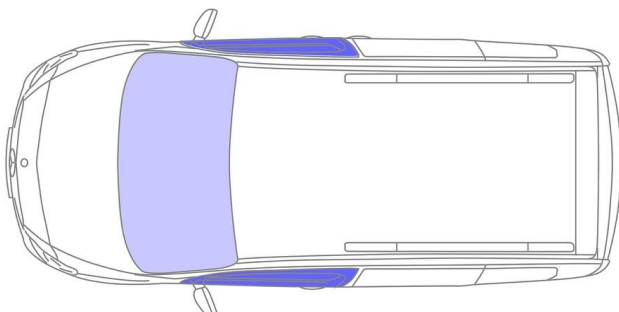

- VSG: laminirano varnostno steklo
- ESG: enoslojno varnostno steklo



## 5. Shranjena energija / tekočine / plini / trdne snovi



Vsi visokonapetostni vodniki so opremljeni z oranžno izolacijo.

## 6. V primeru požara



Fireman Access in the hold.



Za gašenje požara v vozilu uporabite velike količine vode (H<sub>2</sub>O).  
Za hlajenje litij-ionskega akumulatorja uporabite velike količine vode (H<sub>2</sub>O).



Opozorilo: Ponoven vžig akumulatorja



Če hladilno sredstvo izstopa iz visokonapetostnega akumulatorja, lahko zaradi toplotne preobremenitve postane nestabilna. Temperaturo akumulatorja preverite z IR termovizijsko kamero.



## 7. V primeru potopitve

Ni nevarnosti, da bi na karoseriji prišlo do napetosti.

Po reševanju vozila:

1. Pustite, da voda iz notranjosti odteče.
2. Zaženite deaktivacijo visokonapetostnega sistema (glejte poglavje 3).

## 8. Vleka / prevoz / shranjevanje

Vozilo prevažajte na vlečnem vozilu ali avtotransporterju samo z obema osema.

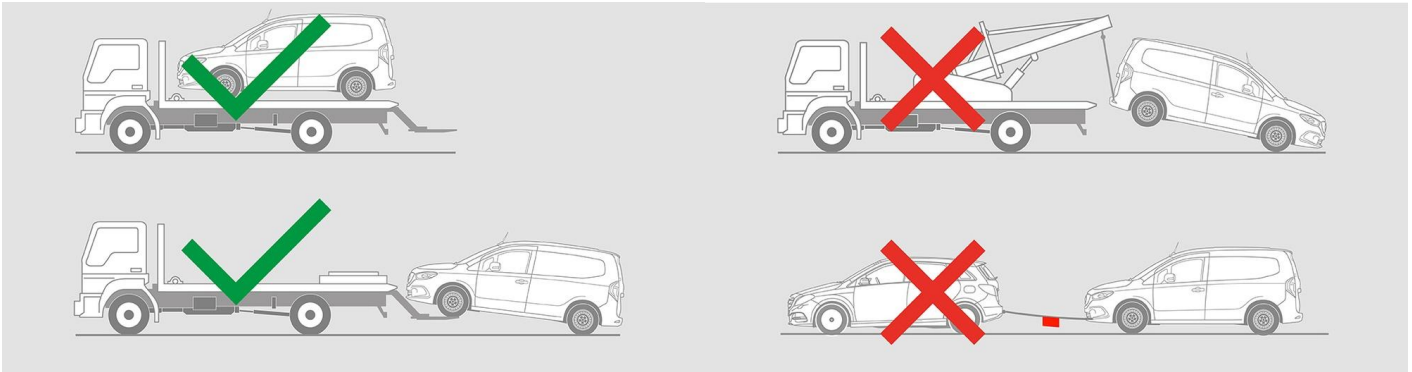

Shranite ga na varni razdalji od drugih vozil.



Opozorilo: Ponoven vžig akumulatorja



## 9. Pomembne dodatne informacije

Nadaljnje informacije najdete v [Vodniku vlečne službe za osebna vozila](#).



## 10. Razlaga uporabljenih piktogramov



Električno vozilo



Splošen opozorilni znak



Opozorilo, elektrika



Vnetljivo



Nevarnost za zdravje ljudi



Jedke snovi



Akutna strupenost



Za gašenje požara uporabite vodo



Safety gloves



Face shield



Uporaba termične infrardeče kamere



Pokrov



Odstranite pametni ključ



Poseben dostop do baterije