

- Airbag
- Gasgenerator
- Forspænder til sikkerhedssele
- SRS kontrolenhed
- Gastryksdæmper/forspændt fjeder
- Lavspændingsbatteri
- Diesel brændstofftank

Bemærkning: For yderligere oplysninger henvises til vores [redningsvejledning](#).

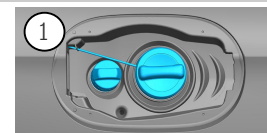

### 1. Identifikation / genkendelse

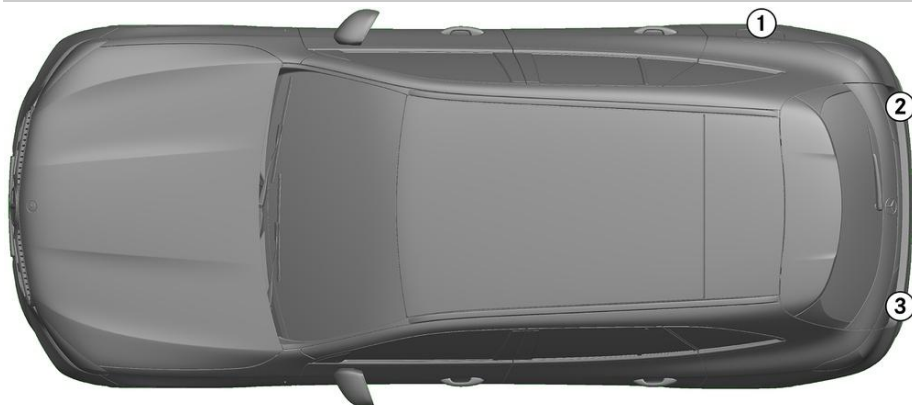

### 2. Immobilisering / Stabillisering / Løft

#### Parkeringsbremse

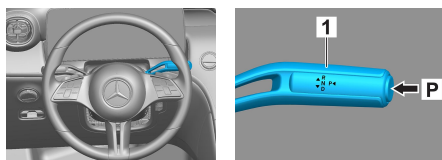

#### Håndbremse

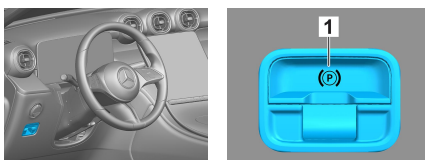

Tryk på kontakten P på gearvælgeren (1). Parke-  
ringsbremsen aktiveres automatisk.

Elektrisk håndbremse (1)

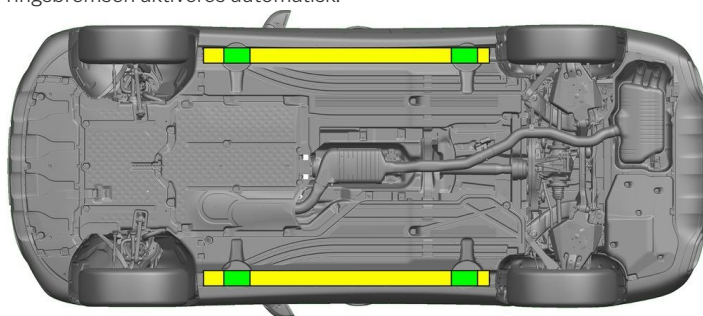

- Egnede løftepunkter
- Egnede stabiliseringspunkter på siden



Yderligere deformering af karme og undervogn under bjærgningen (f.eks. ved afstivning med hydraulisk udstyr) skal undgås.

### 3. Deaktivering særlige farer / sikkerhedsforskrifter

#### Slå tændingen fra:

1. Tryk på START-STOP-knappen uden at aktivere driftsbremsen.
2. Hold den elektroniske køretøjsnøgle i en afstand på mindst 5 m.

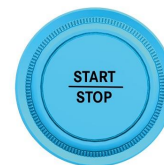
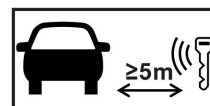

Fraværet af motorlyde betyder ikke, at køretøjet er slukket.



En genstart er mulig, indtil køretøjet tages ud af drift.



#### Afbryd 48-V-batteriet

1. Fjern dækslet til 48-voltsbatterierne i motorrummet.
2. Løsn minuskablet på 48-voltsbatteriet ved skrueforbindelsen, og sikr det mod utilsigtet kontakt.





### Afbryd 12 V-batteriet



1. Fjern dækslet til 12-voltsbatterierne i bagagerummet.
2. Løsn minuskablet på 12-voltsbatteriet ved skrueforbindelsen, og sikr det mod utilsigtet kontakt.



De passive sikkerhedssystemer (airbags og forspændere til sikkerhedssele) deaktiveres.

## 4. Adgangveje til tilskadekommande

Ved frigørelse af personerne i bilen skal der tages hensyn til komponenterne i sikkerhedssystemerne (især pyrotekniske elementer) i overensstemmelse med angivelserne på side 1.

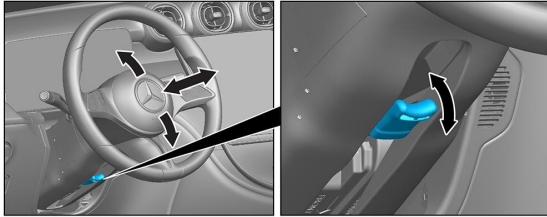

Ratindstilling

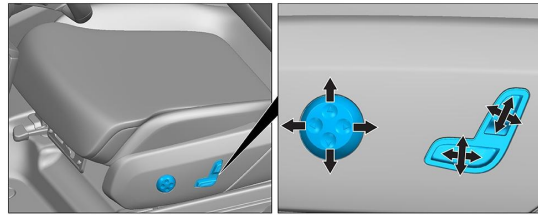

Sædeindstilling (elektrisk)

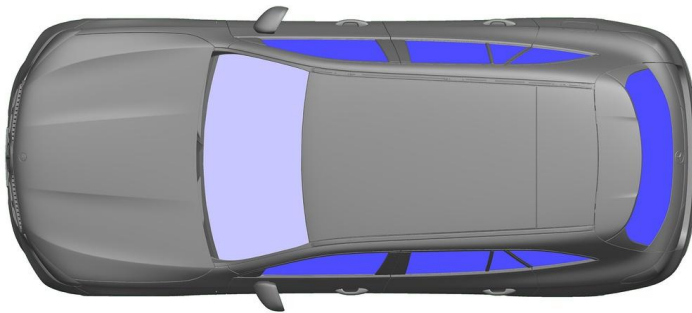

- VSG: lamineret sikkerhedsglas
- ESG: hærdet glas

## 5. Oplagret energi / væsker / gasser / faste stoffer



## 6. I tilfælde af brand



Brug store mængder vand (H<sub>2</sub>O), når en køretøjsbrand skal slukkes.

## 7. I vand

Der er ingen fare ved, at der er spænding på karrosseriet. Efter bjærgning af køretøjet:

1. Lad vandet løbe ud af kabinen.
2. Påbegynd deaktivering af 12-/48-voltsledningsnettet (se kapitel 3).

## 8. Bugsering / transport / opbevaring

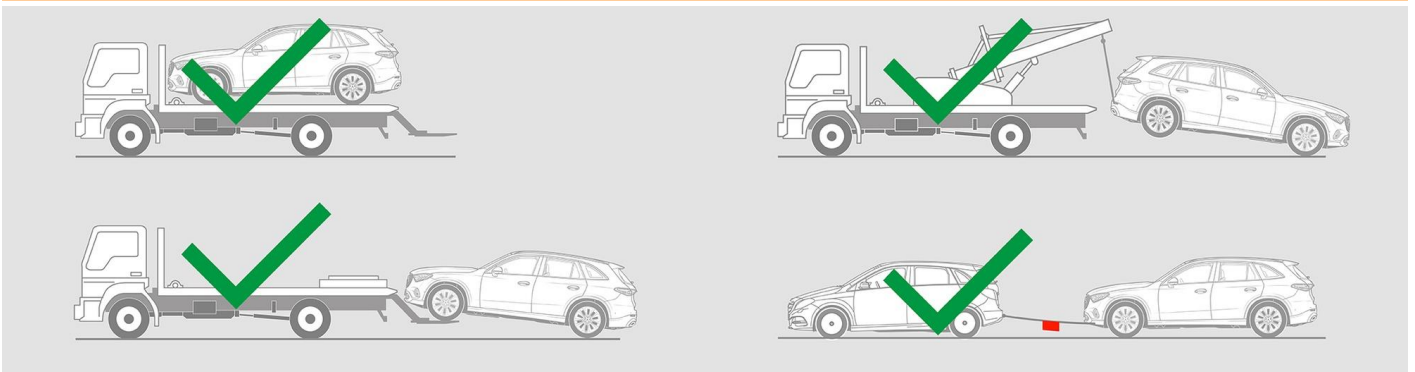



## 9. Vigtige ekstra oplysninger

Yderligere oplysninger findes i [Vejledning for bjærgningsfirmaer, personvogne](#).

## 10. Piktogram information



Køretøj på brændstof i klasse 1



Generelt advarsskilt



Brandfarligt



Farligt for menneskers sundhed



Ætsende



Akut toksicitet



Brug vand til at slukke ilden



Brug tørt skum til at slukke ilden



Brug vådt skum til at slukke ilden



Motorhjelm



Bagagerum



Fjern smart nøgle