













- ① Hoofdaccu (12 V)
- ② Extra accu
- ③ Hoogspanningsaccu
- ④ Oplaadstekkerdoos hoogspanning
- ⑤ Hoogspanningsuitschakelvoorziening
- ⑥ Alternatieve hoogspanningsuitschakelvoorziening

 Airbag	 Gasgenerator	 Gordelspanner	 Gasdrukdemper	 Brandstoftank
 Regeleenheid veiligheidssystemen	 Accu 12 V	 Hoogspanningsaccu	 Hoogspanningsonderdelen	 Hoogspanningsuitschakelvoorziening
 Alternatieve hoogspanningsuitschakelvoorziening	 Voetangersbescherming			

Let op: Meer informatie vindt u in onze [Leidraad voor hulpdiensten](#).



## 1. Identificatie / herkenning

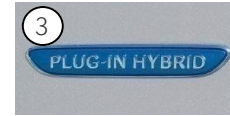
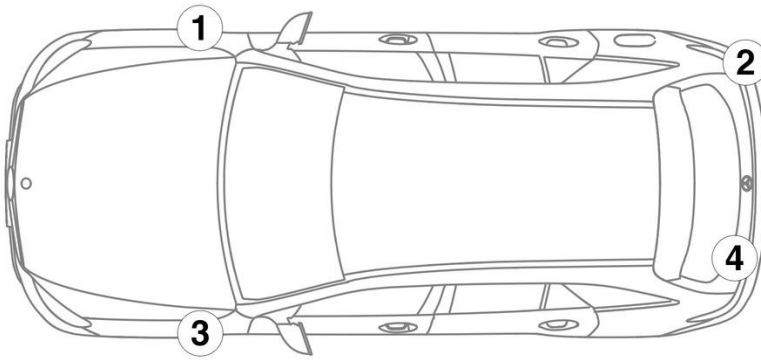

## 3. Directe gevaren uitschakelen / veiligheidsvoorschriften

### Deactiveren van het hoogspanningssysteem

In alle andere gevallen moet het hoogspanningssysteem als volgt worden gedeactiveerd:

#### Optie 1: Uitschakelinrichting voor de hoogspanning

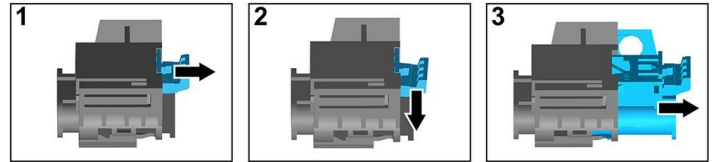
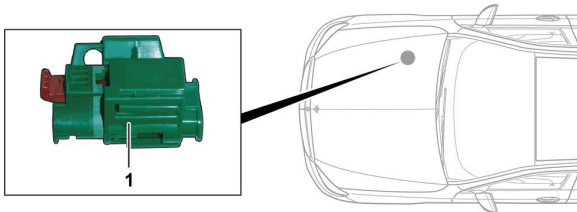

De uitschakelinrichting voor de hoogspanning bevindt zich in de motorruimte aan de passagierszijde.



- (1) Aan ontgrendeling trekken
- (2) Ontgrendeling omlaag duwen
- (3) Schakelaar eruit trekken



#### Optie 2: Alternatieve uitschakelinrichting voor de hoogspanning

De alternatieve uitschakelinrichting voor de hoogspanning bevindt zich onder de afdekking van de zekeringkast aan de cockpit aan de bestuurderskant.

Ze is gemarkeerd met een aanwijzingsplaatje.

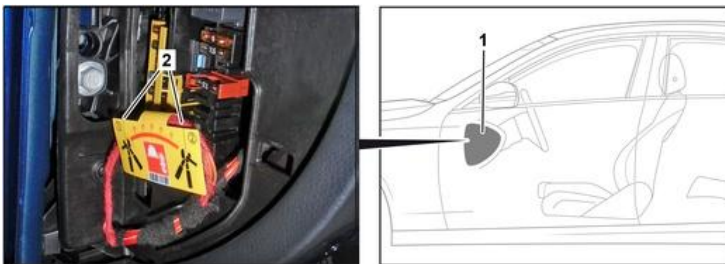

Afdekking (1) verwijderen. Kabel aan het gemarkeerde punt (2) doorknippen.



#### 12V-accu afklemmen

1. Afdekking van de 12V-accu verwijderen.
2. Minuskabel van de 12V-accu aan de schroefverbinding losmaken en deze beveiligen tegen onbedoeld contact.

