









- |   |  |  |   |   |
|---|--|--|---|---|
|  Turvatyyny                    |  Kaasugeneraattori  |  Turvavyön kiristin |  SRS-ohjainlaite           |  Aktiivinen jalankulkijasuojajärjestelmä |
|  Automaattinen ympäryörähdysuo |  Kaasujousi / teijä |  Matalajänniteakku  |  Bensiini polttoainesäiliö |   |

Ohje: Katso lisätietoja [pelastusohjeestamme](#).



## 1. Ajoneuvon tunnistaminen/ identifiointi

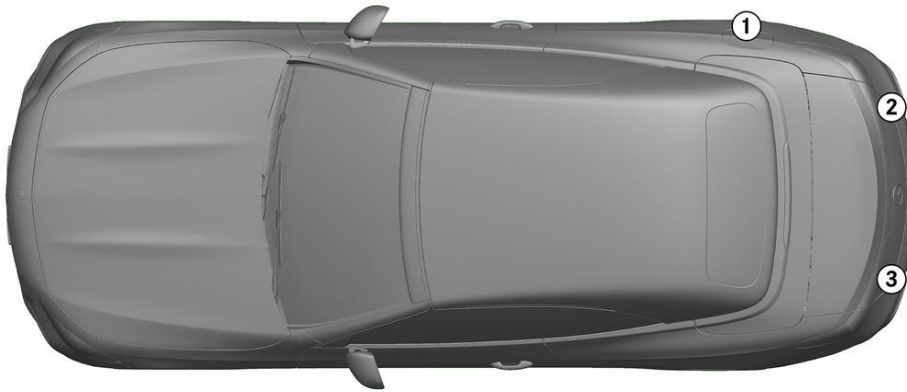

## 2. Ajoneuvon sammuttaminen / stabilointi

## Seisontajarru

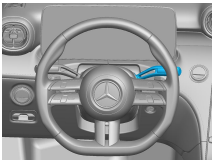

## Seisontajarru

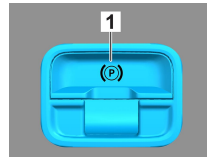
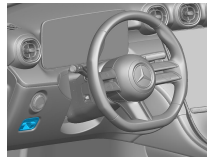

Paina kytkintä P vaihtevalitsimessa (1).

Seisontajarru aktivoituu automaattisesti.

Sähköinen seisontajarru (1)

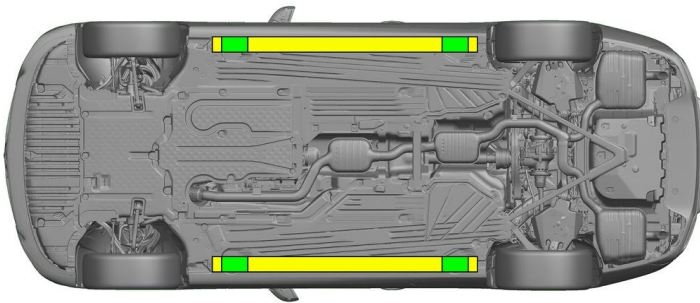

Soveltuvat nostopisteet



Soveltuvat vakautuspisteet sivulla



Kynnyksen ja pohjan lisääntyminen pelastuksen aikana (esim. tuenta hydraulikkavarusteilla) on vältettävä.

## 3. Ajoneuvon vaarattomaksi tekeminen

## Kytke sytytysvirta pois päältä:

1. Paina START-STOP-painiketta painamatta käyttöjarrua.
2. Säilytä ajoneuvon sähköinen avain vähintään 5 metrin etäisyydellä.

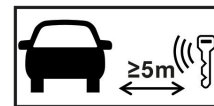

## 48 V:n akun kytkeminen irti

1. Poista 48 V:n akun suojus moottoritilasta.
2. Irrota 48 V:n akun miinusjohto ruuviliitännästä ja varmista tahattoman kosketuksen estämiseksi.



## 12 V:n akun kytkeminen irti

1. Poista 12 V:n akun suojus tavaratilasta.
2. Irrota 12 V:n akun miinusjohto ruuviliitännästä ja varmista tahattoman kosketuksen estämiseksi.



Passiiviset turvajärjestelmät (turvatyynyt ja turvavyönkiristimet) deaktivoituvat.



#### 4. Ajoneuvon sisällä olevien pelastaminen

Vapautettaessa autossa matkustavia henkilöitä on huomioitava turvavarusteiden komponentit (erityisesti pyrotekniset elementit) sivulla 1 olevien tietojen mukaisesti.



Ohjauspyörän säätö



Istuimen säätö (sähköinen)

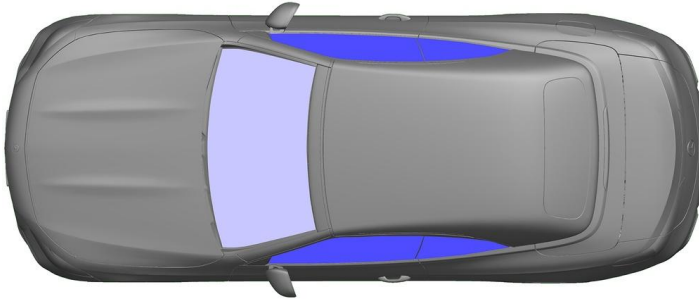

- VSG: Laminoitu varmuuslasi
- ESG: Karkaistu varmuuslasi

#### 5. Ajoneuvon käyttövoima, nesteet, kiinteät aineet

						12/48V
						66L
						570 ± 10g

#### 6. Toimenpiteet tulipalon sattuessa



Käytä ajoneuvopalon sammuttamiseen suuria määriä vettä (H<sub>2</sub>O).

#### 7. Toimenpiteet auton joutuessa hukuksiin

Ei ole vaaraa, että korissa olisi jännite. Ajoneuvon pelastamisen jälkeen:

1. Anna veden virrata pois sisätilasta.
2. Deaktivoi ajoneuvon 12 V:n / 48 V:n sähköverkko (katso luku 3).

#### 8. Hinaaminen / Kuljetus / Varastointi

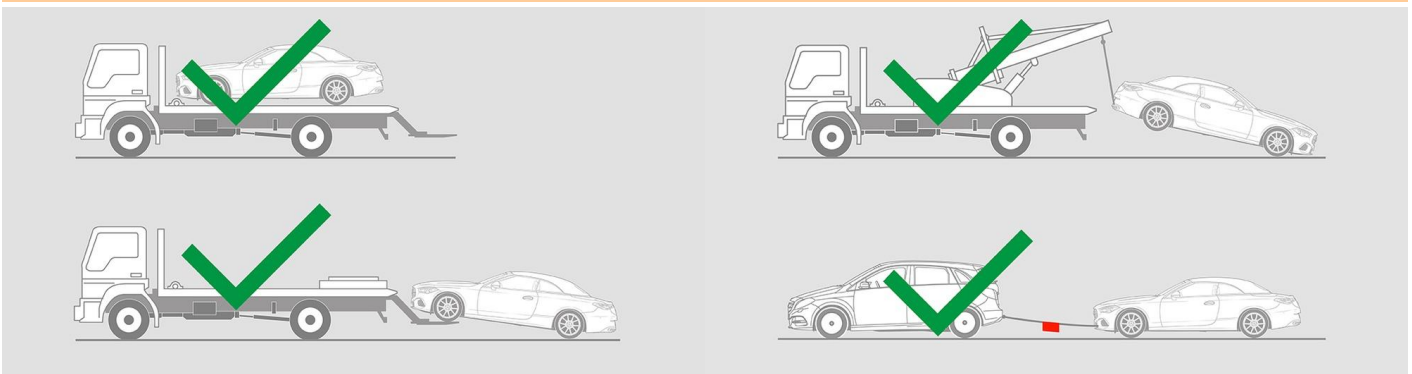



## 9. Tärkeitä lisätietoja

Lisätietoja on kohdassa [Ohjeet henkilöautojen hinauspalveluille](#).

## 10. Merkkien selitykset



Luokan 2 nestemäisiä polttoaineita käyttävä auto



Vaara



Syttyvä



Terveydelle haitallinen



Syövyttävä



Välitön myrkyllisyys



Herkästi räjähtävä



Sammuta vedellä



Sammuta kuivalla vaahdolla



Sammuta kostealla vaahdolla



Konepelti



Matkatavaratila



Smart-avaimen poistaminen



Air-conditioning component



Warning; low temperature