

-  Krockkudde
-  Gasgenerator
-  Bältesförsträckare
-  SRS styrenhet
-  Aktivt fotgängarskyddssystem
-  Automatiskt överrullningskyddssystem
-  Gastrycksdämpare/förspänd fjäder
-  Lågvoltsbatteri
-  Bensin bränsletank

Observera: Mer information finns i vår [räddningsguide](#).

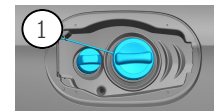

### 1. Identifiering

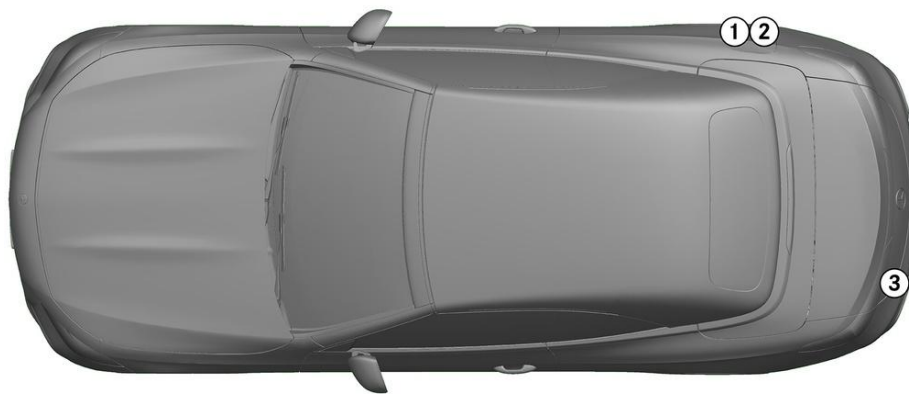

### 2. Immobilisering / stabilisering / lyft

#### Parkeringsbroms

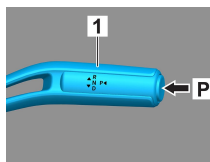
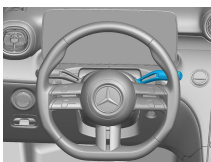

#### Parkeringsbroms

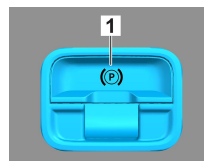
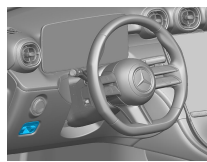

Tryck på strömbrytaren P på växelväljaren (1).  
Parkeringsbromsen aktiveras automatiskt.

Elektrisk parkeringsbroms (1)

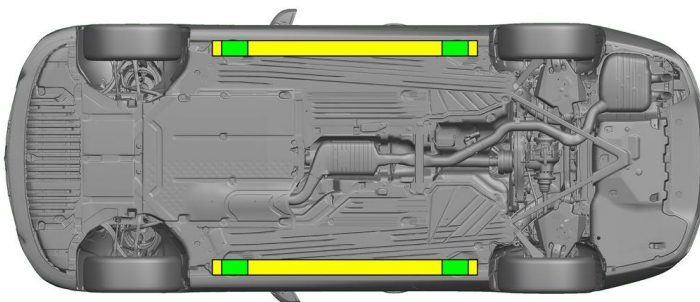

Lämpliga lyftpunkter



Lämpliga stabiliseringspunkter på sidan



Undvik att ytterligare deformera trösklarna och underredet under räddningsinsatsen (exempelvis genom att använda dem som stöd för hydraulisk utrustning).

### 3. Oskadliggöra akuta risker/ säkerhetsföreskrifter

#### Slå av tändningen:

1. Tryck på START-STOP-knappen utan att manövrera färdbromsen.
2. Förvara den elektroniska fordonsnyckeln på minst 5 m avstånd.

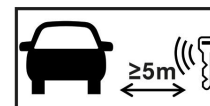

#### Koppla loss 48-voltsbatteriet

1. Ta bort övertäckningen från 48-voltsbatteriet i motorrummet.
2. Lossa minuskabeln från skruvförbandet på 48-voltsbatteriet och säkra den mot oavsiktlig kontakt.



#### Koppla loss 12-voltsbatteriet

1. Ta bort övertäckningen från 12-voltsbatteriet i bagageutrymmet.
2. Lossa minuskabeln från skruvförbandet på 12-voltsbatteriet och säkra den mot oavsiktlig kontakt.



De passiva säkerhetssystemen (airbags och bältesförsträckare) inaktiveras.



### 4. Åtkomst till passagerare

När personerna i bilen frigörs måste hänsyn tas till säkerhetssystemets komponenter (särskilt pyrotekniska element) i enlighet med informationen på sidan 1.

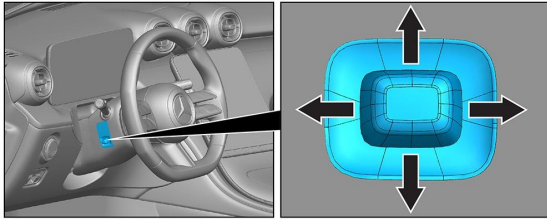

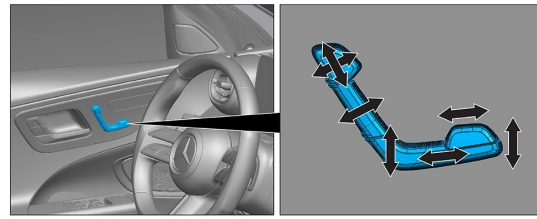

Rattinställning



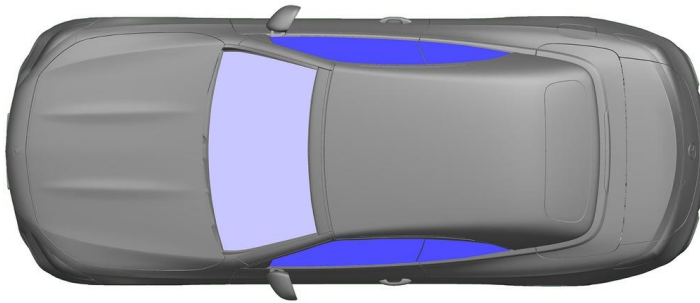















Stolsinställning (elektrisk)



 VSG: Laminerat säkerhetsglas

 ESG: enkelt säkerhetsglas

### 5. Lagrad energi / vätskor / gaser / fasta ämnen

	    	12/48V
	 	66L
	 	66L
	  	570 ± 10g

### 6. I händelse av brand



Använd stora mängder vatten (H<sub>2</sub>O) vid släckning av fordonsbränder.

### 7. Om fordonet är nedsänkt i vatten

Det finns ingen fara för att karossen är spänningssatt. Efter bärgning av fordonet:

- Låt vattnet rinna ut ur kupén.
- Inled inaktivering av elsystemet med 12/48 volt (se kapitel 3).

### 8. Bogsering / transport / förvaring

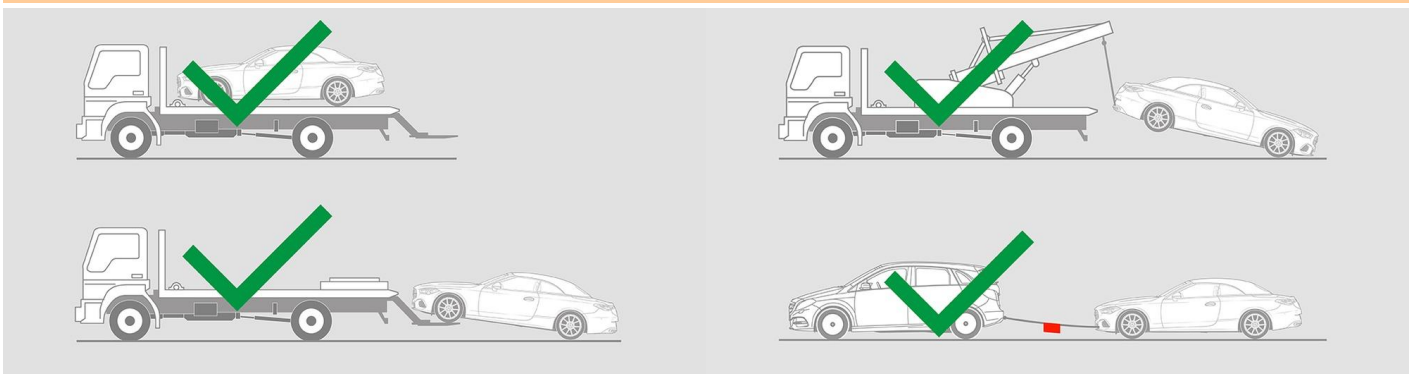



## 9. Övrig viktig information

Mer information finns i [Guide till personbilsbärgare](#).

## 10. Förklaring till de pictogram som används



Bränslefordon från vätskegrupp 1



Bränslefordon från vätskegrupp 2



Allmän varningsskylt



Brandfarligt



Farligt för människors hälsa



Frätande medel



Akut toxicitet



Explosivt



Använd vatten för att släcka elden



Använd torrskum för att släcka elden



Använd våtskum för att släcka elden



Motorhuv



Bagageutrymme



Ta bort smartnyckeln



Luftkonditioneringskomponent



Diesel bränsletank



Varning, låg temperatur