









- |   |   |   |                                     |   |  |   |                                 |   |  |
|---|---|---|-------------------------------------|---|--|---|---------------------------------|---|--|
|  | Airbag                                    |  | Generator de gaz                    |  | Sistem de pre-tensionare a centurilor de siguranță |  | Unitate de control SRS          |  | Sistem activ de protecție a pietonilor |
|  | Sistem de protecție automat la răsturnare |  | Amortizor cu gaz / arc pretensionat |  | Acumulator de joasă tensiune                       |  | Benzină Rezervor de combustibil |   |  |

Indicație: Pentru mai multe informații, vă rugăm să consultați ghidurile [operaționale de salvare](#).



### 1. Identificare / recunoaștere

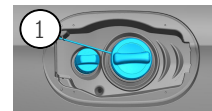
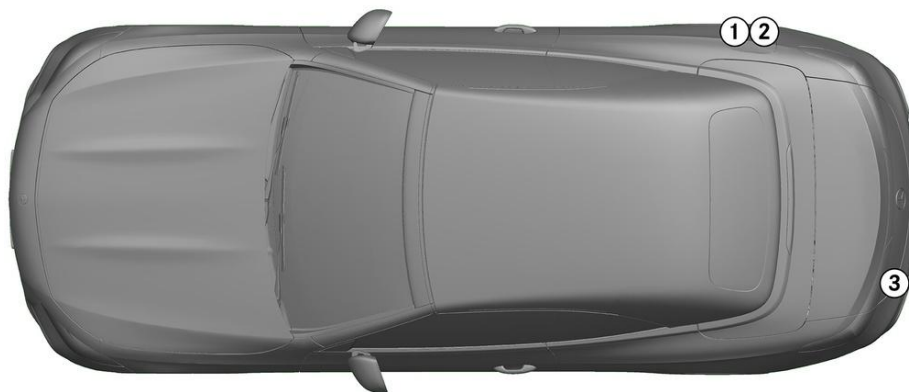

### 2. Imobilizare / stabilizare / ridicare

#### Frână de staționare

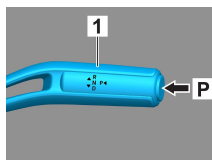

#### Frână de parcare

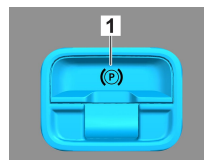
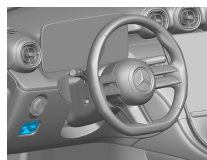

Apăsați comutatorul P pe maneta de selectare (1). Frâna de staționare este activată automat.

Frână de parcare electrică (1)

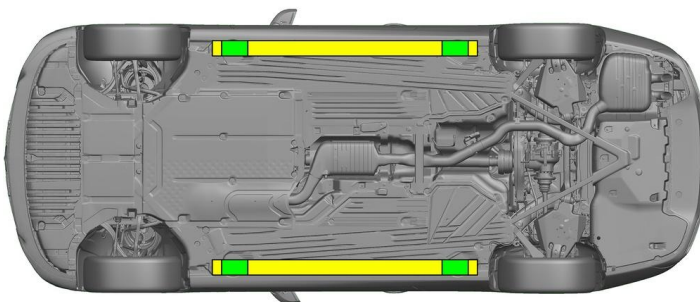

Puncte de ridicare adecvate



Puncte de stabilizare adecvate pe lateral



Trebuie să se evite deformarea suplimentară a pragurilor și a șasiului în timpul operațiunii de salvare (de ex. prin susținere cu echipament hidraulic).

### 3. Înlăturare pericole / reguli de securitate

#### Decuplați aprinderea:

1. Apăsați butonul START-STOP fără a acționa frâna de serviciu.
2. Păstrați cheia electronică a vehiculului la o distanță de cel puțin 5 m.

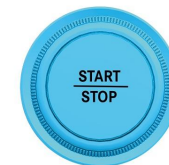
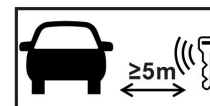

#### Deconectați bateria de 48 V

1. Îndepărtați capacul bateriei de 48 V din camera motorului.
2. Slăbiți cablul minus al bateriei de 48 V la conexiunea cu șurub și asigurați-l împotriva contactului nedorit.



#### Deconectați bateria de 12 V

1. Îndepărtați capacul bateriei de 12 V din portbagaj.
2. Slăbiți cablul minus al bateriei de 12 V la conexiunea cu șurub și asigurați-l împotriva contactului nedorit.



Sistemele de siguranță pasivă (airbagurile și sistemele de pretensionare a centurilor de siguranță) sunt dezactivate.



### 4. Accesul către ocupanți

La eliberarea ocupanților autovehiculului, trebuie să se țină seama de componentele sistemelor de siguranță pasivă (în special elementele pirotehnice), conform indicațiilor specificate la pagina 1.

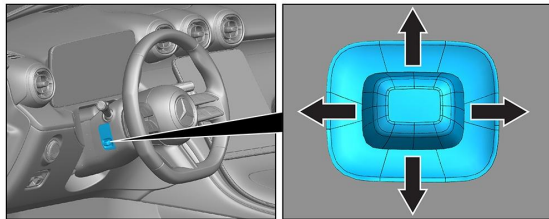

Reglarea volanului

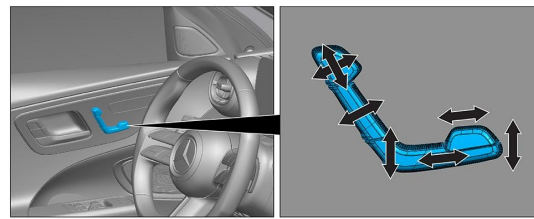

Reglarea scaunului (electrică)

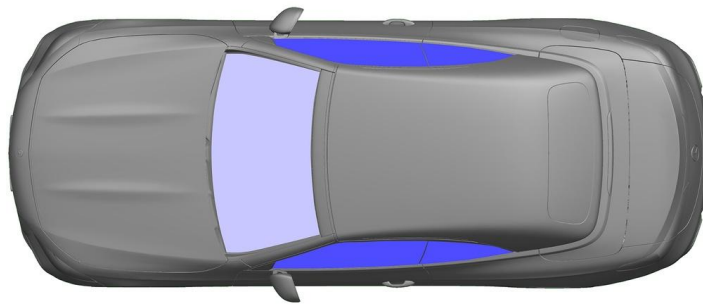

- VSG: Sticlă securizată laminată
- ESG: Sticlă securizată cu o singură foaie

### 5. energie stocată / lichide / gaze / solide

		12/48V
		66L
		66L
		570 ± 10g

### 6. În caz de incendiu



Pentru a stinge un incendiu la vehicul utilizați cantități mari de apă (H<sub>2</sub>O).

### 7. În cazul submersiei

Nu există niciun pericol de tensiune la caroserie. După recuperarea vehiculului:

1. Lăsați să se scurgă apa din habitacul.
2. Inițiați dezactivarea rețelei de bord de 12 V/48 V (a se vedea capitolul 3).

### 8. Tractare / transport / depozitare

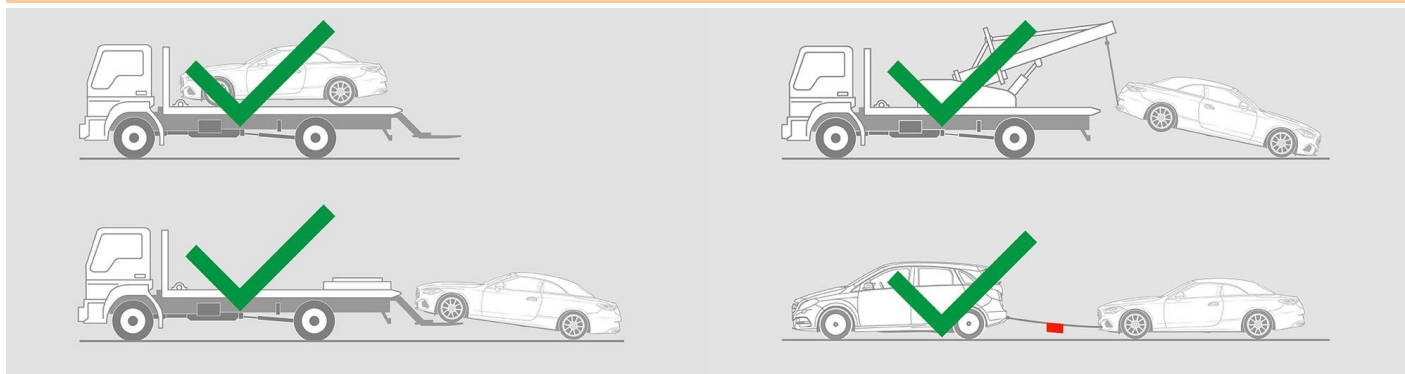



## 9. Informații adiționale importante

Mai multe informații puteți găsi în [Linii directoare pentru serviciile de tractare a autoturismelor](#).

## 10. Explicarea pictogramelor utilizate



Vehicul alimentat cu combustibil din grupa de fluide 1



Vehicul alimentat cu combustibil din grupa de fluide 2



Simbol de avertizare generală



Inflamabil



Periculos pentru sănătatea umană



Coroziv



Toxicitate acută



Exploziv



Folosiți apă pentru a stinge incendiul



Folosiți spumă uscată pentru a stinge incendiul



Folosiți spumă umedă pentru a stinge incendiul



Capotă



Portbagaj



Îndepărtați cheia inteligentă



Componentă a sistemului de aer condiționat



Motorină Rezervor de combustibil



Avertisment; temperatură scăzută