

-  Airbag
-  Gasgenerator
-  Forspænder til sikkerhedssele
-  SRS kontrolenhed
-  Aktivt fodgængerbeskyttelsessystem
-  Automatisk styrtbeskyttelsessystem
-  Gastryksdæmper/forspændt fjeder
-  Lavspændingsbatteri
-  Diesel brændstoftank

Bemærkning: For yderligere oplysninger henvises til vores [redningsvejledning](#).

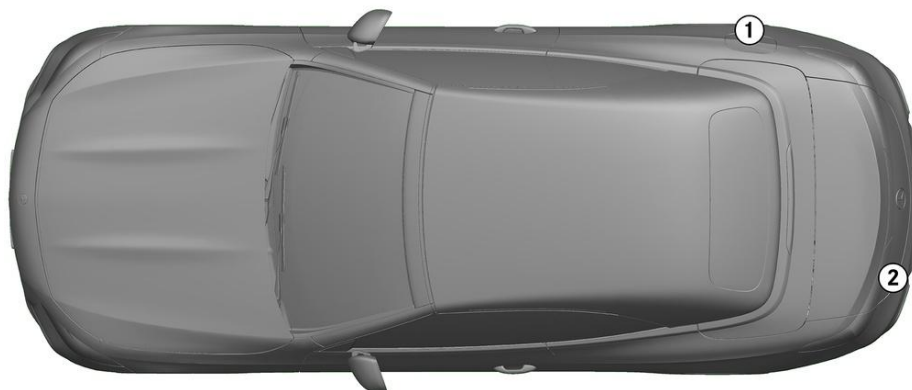

1. Identifikation / genkendelse



②
CLE 220d

2. Immobilisering / Stablisering / Løft

Parkeringsbremse

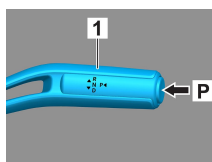
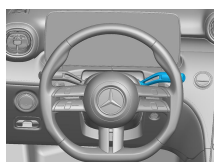

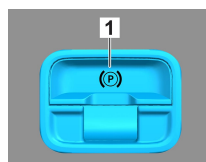
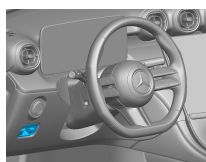

Håndbremse

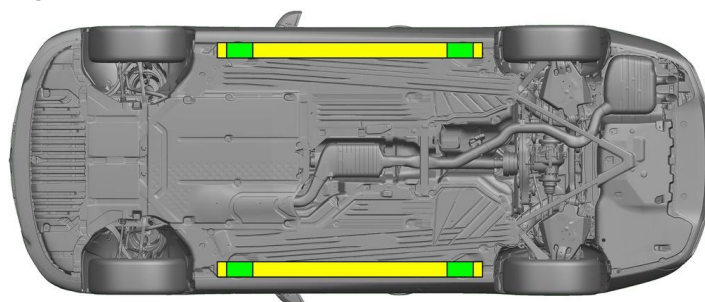

Tryk på kontakten P på gearvælgeren (1). Parke-
ringsbremsen aktiveres automatisk.

Elektrisk håndbremse (1)



-  Egnede løftepunkter
-  Egnede stabiliseringspunkter på siden



Yderligere deformering af karmer og undervogn under bjærgningen (f.eks. ved afstivning med hydraulisk udstyr) skal undgås.

3. Deaktivering særlige farer / sikkerhedsforskrifter

Slå tændingen fra:

- Tryk på START-STOP-knappen uden at aktivere driftsbremsen.
- Hold den elektroniske køretøjsnøgle i en afstand på mindst 5 m.

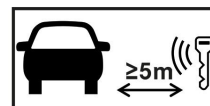

Afbryd 48-V-batteriet

- Fjern dækslet til 48-voltsbatterierne i motorrummet.
- Løsn minuskablet på 48-voltsbatteriet ved skrueforbindelsen, og sikr det mod utilsigtet kontakt.



Afbryd 12 V-batteriet

- Fjern dækslet til 12-voltsbatterierne i bagagerummet.
- Løsn minuskablet på 12-voltsbatteriet ved skrueforbindelsen, og sikr det mod utilsigtet kontakt.



De passive sikkerhedssystemer (airbags og forspændere til sikkerhedssele) deaktiveres.



4. Adgangveje til tilskadekommande

Ved frigørelse af personerne i bilen skal der tages hensyn til komponenterne i sikkerhedssystemerne (især pyrotekniske elementer) i overensstemmelse med angivelserne på side 1.



Ratindstilling



Sædeindstilling (elektrisk)

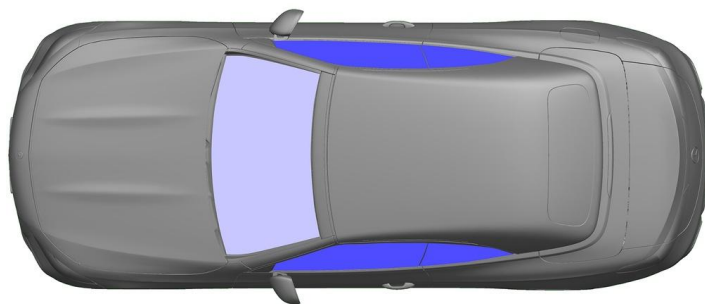

- VSG: lamineret sikkerhedsglas
- ESG: hærdet glas

5. Oplagret energi / væsker / gasser / faste stoffer

		12/48V
		66L
		570 ± 10g

6. I tilfælde af brand



Brug store mængder vand (H₂O), når en køretøjsbrand skal slukkes.

7. I vand

Der er ingen fare ved, at der er spænding på karrosseriet. Efter bjærgning af køretøjet:

1. Lad vandet løbe ud af kabinen.
2. Påbegynd deaktivering af 12-/48-voltsledningsnettet (se kapitel 3).

8. Bugsering / transport / opbevaring

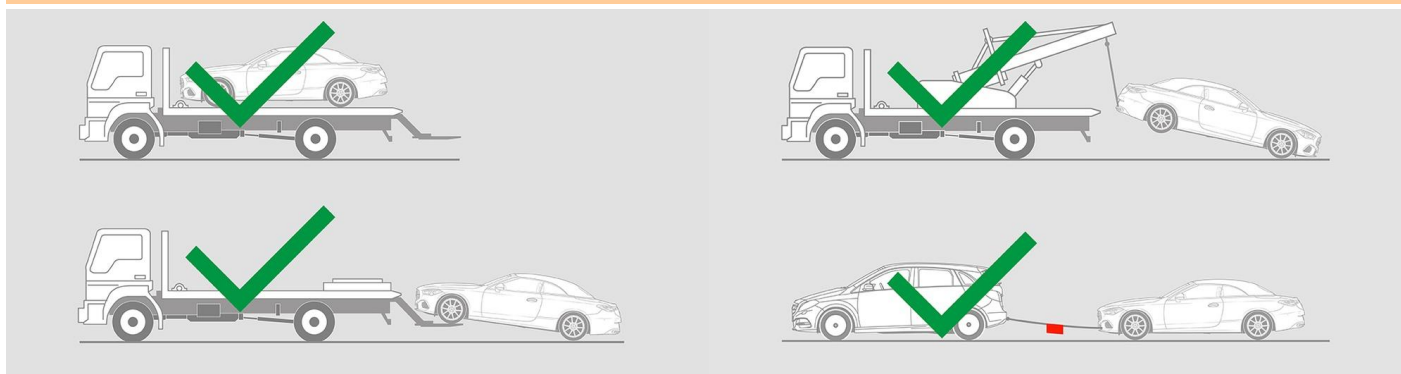



9. Vigtige ekstra oplysninger

Yderligere oplysninger findes i [Vejledning for bjærgningsfirmaer, personvogne](#).

10. Piktogram information

	Køretøj på brændstof i klasse 1		Generelt advarselsskilt		Brandfarligt		Farligt for menneskers sundhed
	Ætsende		Akut toksicitet		Eksplosiv		Brug vand til at slukke ilden
	Brug tørt skum til at slukke ilden		Brug vådt skum til at slukke ilden		Motorhjelme		Bagagerum
	Fjern smart nøgle		Klimaanlæg		Advarsel; lav temperatur		