

-  Zračni meh
-  Plinski generator
-  Zateznik varnostnega pasu
-  Krmilna enota za pomožni omejevalni sistem SRS
-  Aktivni sistem za zaščito pešcev
-  Plinski blažilnik/prednapeta vzmet
-  Nizkovoltni akumulator
-  Dizel rezervoar za gorivo
-  Baterijski sklop, visokonapetostni
-  Visokonapetostni električni kabel
-  Komponenta za visoko napetost
-  Pretrganje kablov
-  Nizkonapetostna naprava, ki izklopi visoko napetost

Napotek: Za več informacij si oglejte naš [reševalni vodnik](#).



1. Identifikacija / prepoznavanje



C 300 de

2. Imobilizacija / stabilizacija / dvig

Ročna zavora

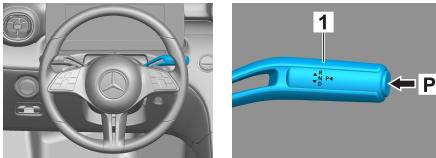

Parkirna zavora

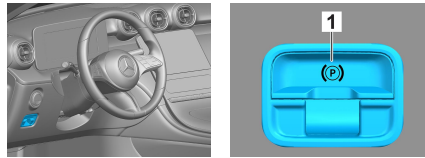

Pritisnite stikalo P na izbirni ročici (1). Ročna zavora se aktivira samodejno.

Električna parkirna zavora (1)

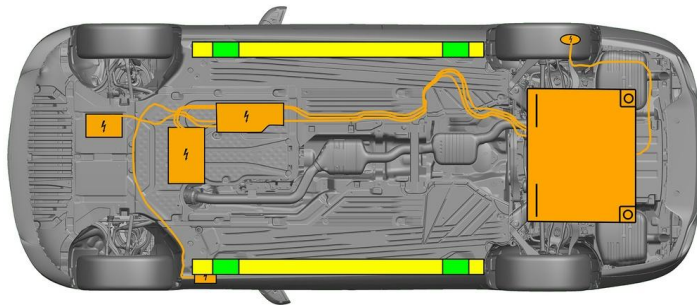

- Ustrezne dvizne točke
- Ustrezne stabilizacijske točke na strani
- Visokonapetostni akumulator



Preprečiti je treba dodatne deformacije pragov in podvozja med reševanjem (npr. s podporo s hidravlično opremo).

3. Onemogočanje neposrednih nevarnosti / varnostni predpisi

Izklop vžiga:

1. Pritisnite tipko START-STOP brez aktiviranja delovne zavore.
2. Elektronski ključ vozila hranite na razdalji najmanj 5 m.

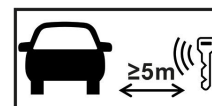

Odsotnost hrupa motorja ne pomeni, da je vozilo izklopljeno.



Ponovni zagon je možen, dokler vozilo ne preneha delovati.

Deaktiviranje visokonapetostnega sistema



V primeru nesreče, v kateri se sprožijo zračne blazine in zategovalniki varnostnega pasu, se visokonapetostni sistem samodejno izklopi.





V vseh drugih primerih je treba visokonapetostni sistem deaktivirati na naslednji način:



Možnost 1: Visokonapetostna odklopna naprava

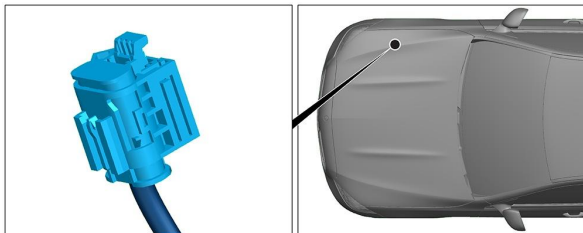

Visokonapetostna odklopna naprava se nahaja v prostoru za motor na sovoznikovi strani.

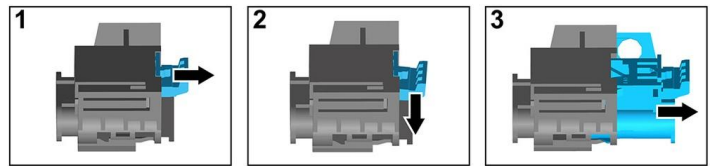

- (1) Povlecite deblokado
- (2) Deblokado pritisnite navzdol
- (3) Izvlecite stikalo



Možnost 2: Alternativna visokonapetostna odklopna naprava

Alternativna visokonapetostna odklopna naprava se nahaja pod pokrovom ohišja z varovalkami na armaturni plošči na voznikovi strani. Označena je s tablico z napotkom.

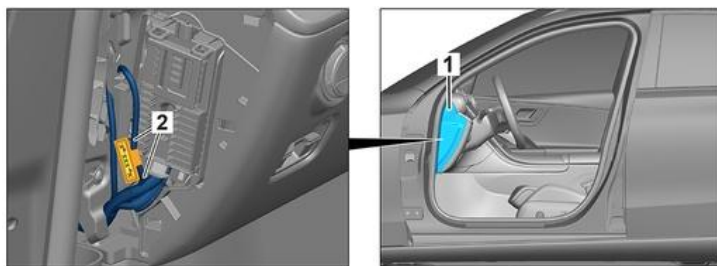

Odstranite pokrov (1). Prerežite vodnik na označenem mestu (2).



Da zagotovite, da v visokonapetostnem omrežju ni preostale napetosti, po izklopu počakajte približno 20 sekund.



Pasivne varnostne sisteme, kot so zračne blazine in zategovalnik varnostnega pasu, še naprej napaja 12-voltni električni sistem vozila.



Odklop 12-V/48-V akumulatorja



1. Odstranite pokrov 12/48-V akumulatorja v prostoru za motor.
2. Odvijte negativni kabel 12/48-V akumulatorja na vijaknem priključku in ga zavarujte pred nenamernim stikom.



Pasivni varnostni sistemi (zračne blazine in zategovalniki varnostnega pasu) se deaktivirajo.

4. Dostop do potnikov

Pri reševanju potnikov upoštevajte komponente zadrževalnih sistemov (posebno pirotehnične elemente) v skladu s podatki na 1. strani.

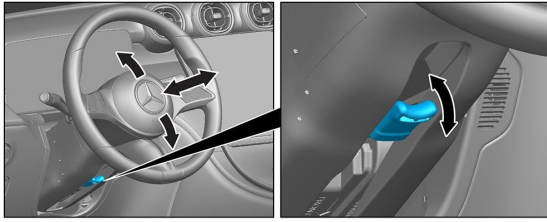

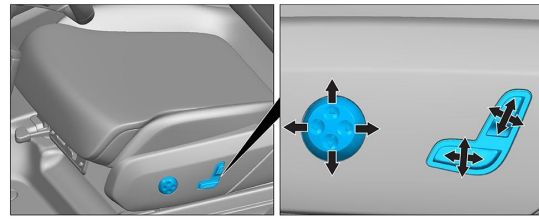

Nastavitev volana

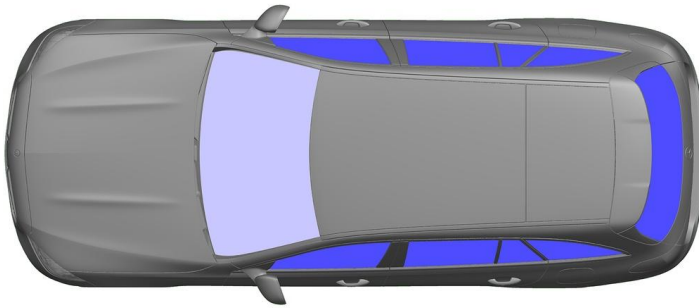

Nastavitev sedeža (električna)



 VSG: laminirano varnostno steklo
 ESG: enoslojno varnostno steklo

5. Shranjena energija / tekočine / plini / trdne snovi



Vsi visokonapetostni vodniki so opremljeni z oranžno izolacijo.

6. V primeru požara



Za gašenje požara v vozilu uporabite velike količine vode (H₂O).
Za hlajenje litij-ionskega akumulatorja uporabite velike količine vode (H₂O).



Opozorilo: Ponoven vžig akumulatorja



Če hladilno sredstvo izstopa iz visokonapetostnega akumulatorja, lahko zaradi toplotne preobremenitve postane nestabilna. Temperaturo akumulatorja preverite z IR termovizijsko kamero.



7. V primeru potopitve

Ni nevarnosti, da bi na karoseriji prišlo do napetosti.

Po reševanju vozila:

1. Pustite, da voda iz notranjosti odteče.
2. Zaženite deaktivacijo visokonapetostnega sistema (glejte poglavje 3).



8. Vleka / prevoz / shranjevanje

Vozilo prevažajte na vlečnem vozilu ali avtotransporterju samo z obema osema.

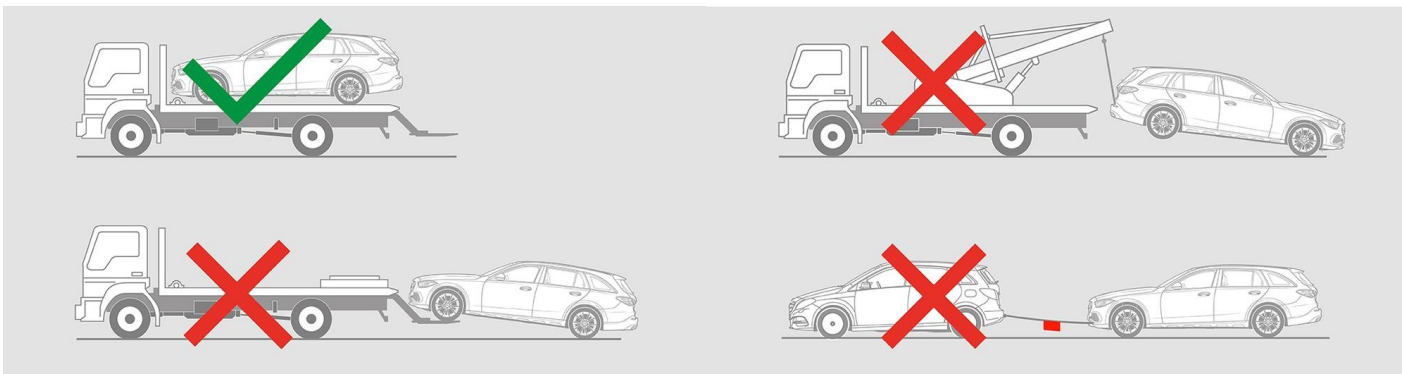

Shranite ga na varni razdalji od drugih vozil.



Opozorilo: Ponoven vžig akumulatorja



9. Pomembne dodatne informacije

Nadaljnje informacije najdete v [Vodniku vlečne službe za osebna vozila](#).

10. Razlaga uporabljenih piktogramov



Hibridno električno vozilo na tekoče gorivo skupine 1



Splošen opozorilni znak



Opozorilo, elektrika



Vnetljivo



Nevarnost za zdravje ljudi



Jedke snovi



Akutna strupenost



Za gašenje požara uporabite vodo



Uporaba termične infrardeče kamere



Pokrov



Odstranite pametni ključ