









- |   |                                    |   |                     |   |                           |   |  |   |                                  |
|---|------------------------------------|---|---------------------|---|---------------------------|---|--|---|----------------------------------|
|  | Zračni meh                         |  | Plinski generator   |  | Zateznik varnostnega pasu |  | Krmilna enota za pomožni omejevalni sistem SRS |  | Aktivni sistem za zaščito pešcev |
|  | Plinski blažilnik/prednapeta vzmet |  | Območje previdnosti |  | Nizkovoltni akumulator    |  | Dizel rezervoar za gorivo                      |   |                                  |

Napotek: Za več informacij si oglejte naš [reševalni vodnik](#).



## 1. Identifikacija / prepoznavanje



①

C 220d

③

4MATIC

## 2. Imobilizacija / stabilizacija / dvig

### Ročna zavora

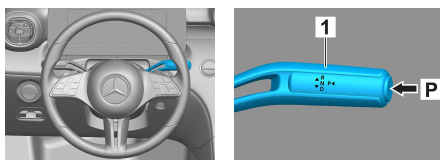

### Parkirna zavora

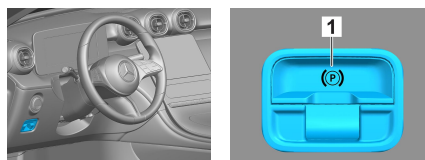

Pritisnite stikalo P na izbirni ročici (1). Ročna zavora se aktivira samodejno.

Električna parkirna zavora (1)

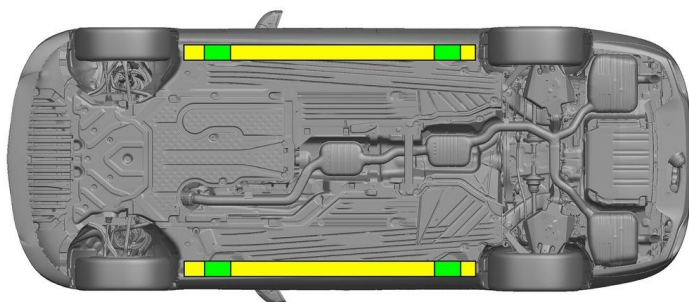

Ustrezne dvizne točke



Ustrezne stabilizacijske točke na strani



Preprečiti je treba dodatne deformacije pragov in podvozja med reševanjem (npr. s podporo s hidravlično opremo).

## 3. Onemogočanje neposrednih nevarnosti / varnostni predpisi

### Izklop vžiga:

1. Pritisnite tipko START-STOP brez aktiviranja delovne zavore.
2. Elektronski ključ vozila hranite na razdalji najmanj 5 m.

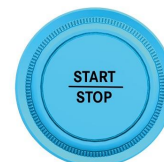
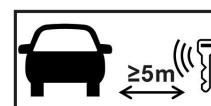

### Odklop 12-V/48-V akumulatorja

1. Odstranite pokrov 12/48-V akumulatorja v prostoru za motor.
2. Odvijte negativni kabel 12/48-V akumulatorja na vijačnem priključku in ga zavarujte pred nenamernim stikom.



### Odklop 12/48-V akumulatorja

1. Odstranite pokrov 12/48-V akumulatorja v prtlačniku.
2. Odvijte negativni kabel 12/48-V akumulatorja na vijačnem priključku in ga zavarujte pred nenamernim stikom.



Pasivni varnostni sistemi (zračne blazine in zategovalniki varnostnega pasu) se deaktivirajo.



## 4. Dostop do potnikov

Pri reševanju potnikov upoštevajte komponente zadrževalnih sistemov (posebno pirotehnične elemente) v skladu s podatki na 1. strani.

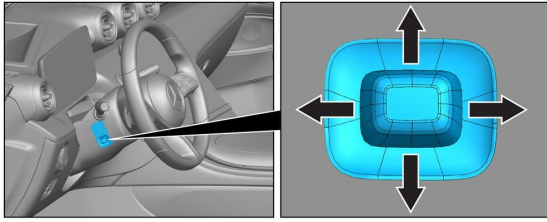

Nastavitev volana

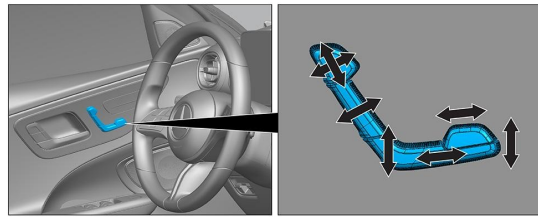

Nastavitev sedeža (električna)

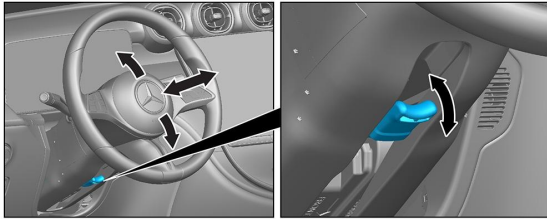

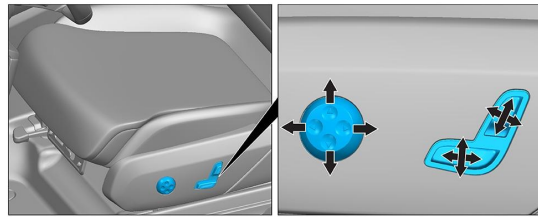

Nastavitev volana

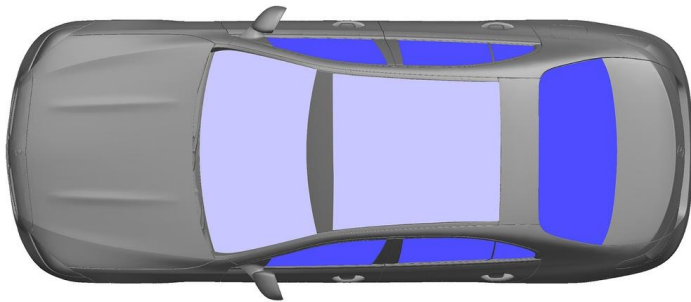

Nastavitev sedeža (električna)



 VSG: laminirano varnostno steklo

 ESG: enoslojno varnostno steklo

## 5. Shranjena energija / tekočine / plini / trdne snovi



## 6. V primeru požara



Za gašenje požara v vozilu uporabite velike količine vode (H<sub>2</sub>O).

## 7. V primeru potopitve

Ni nevarnosti, da bi na karoseriji prišlo do napetosti. Po reševanju vozila:

1. Pustite, da voda iz notranjosti odteče.
2. Zaženite deaktivacijo 12/48-V električnega sistema vozila (glejte poglavje 3).

## 8. Vleka / prevoz / shranjevanje

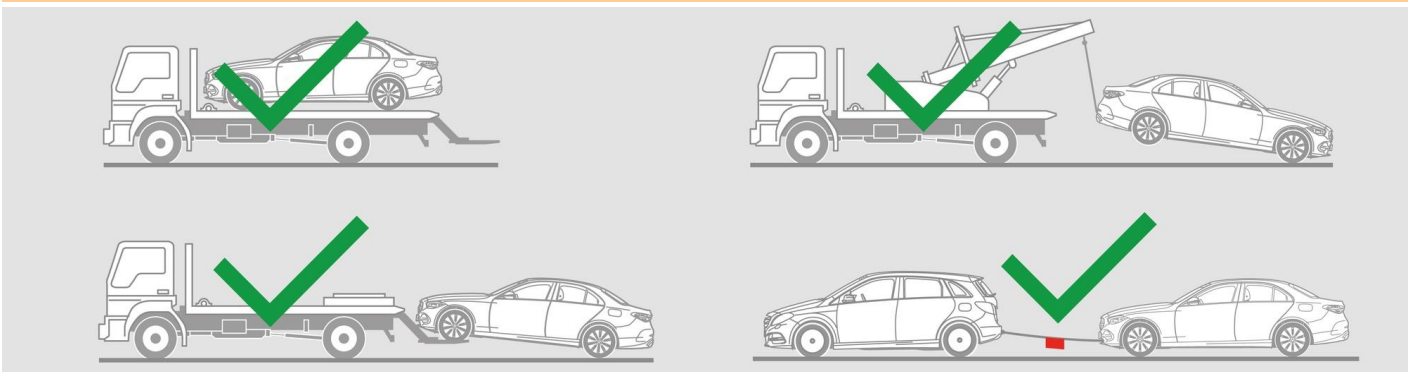



## 9. Pomembne dodatne informacije

Nadaljnje informacije najdete v [Vodniku vlečne službe za osebna vozila](#).

## 10. Razlaga uporabljenih piktogramov



Vozilo na tekoče gorivo skupine 1



Splošen opozorilni znak



Vnetljivo



Nevarnost za zdravje ljudi



Jedke snovi



Akutna strupenost



Za gašenje požara uporabite vodo



Za gašenje požara uporabite suho peno



Za gašenje požara uporabite vlažno peno



Pokrov



Prtljažnik



Odstranite pametni ključ