



- |   |                                 |   |                   |   |                               |   |                      |   |                                     |
|---|---------------------------------|---|-------------------|---|-------------------------------|---|----------------------|---|-------------------------------------|
|  | Airbag                          |  | Gasgenerator      |  | Forspænder til sikkerhedssele |  | SRS kontrolenhed     |  | Aktivt fodgængerbeskyttelses-system |
|  | Gastryksdæmper/forspændt fjeder |  | Forsigtighedszone |  | Lavspændingsbatteri           |  | Diesel brændstoftank |   |                                     |

Bemærkning: For yderligere oplysninger henvises til vores [redningsvejledning](#).



## 1. Identifikation / genkendelse



①

C 220d

②

4MATIC

## 2. Immobilisering / Stablisering / Løft

### Parkeringsbremse

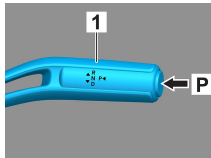

### Håndbremse

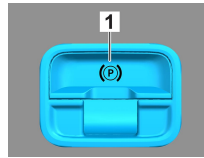

Tryk på kontakten P på gearvælgeren (1). Parkeringsbremsen aktiveres automatisk.

Elektrisk håndbremse (1)

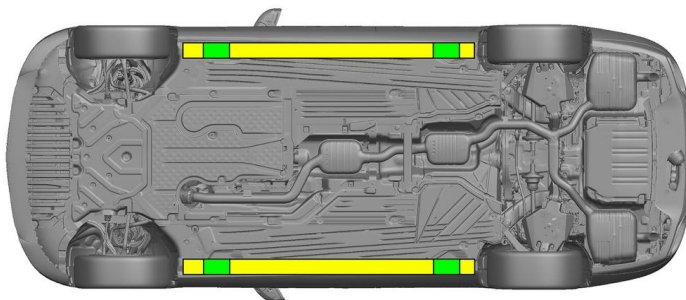

Egnede løftepunkter



Egnede stabiliseringspunkter på siden



Yderligere deformation af karme og undervogn under bjærgningen (f.eks. ved afstivning med hydraulisk udstyr) skal undgås.

## 3. Deaktivering særlige farer / sikkerhedsforskrifter

### Slå tændingen fra:

1. Tryk på START-STOP-knappen uden at aktivere driftsbremsen.
2. Hold den elektroniske køretøjsnøgle i en afstand på mindst 5 m.

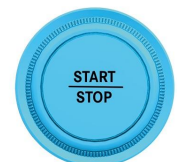
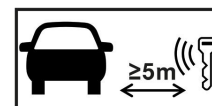

### Afbryd 12 V-/48-V-batteriet

1. Fjern dækslet til 12-/48-voltsbatterierne i motorrummet.
2. Løsn minuskablet på 12-/48-voltsbatteriet ved skrueforbindelsen, og sikr det mod utilsigtet kontakt.



### Afbryd 12/48 V-batteriet

1. Fjern dækslet til 12/48-voltsbatterierne i bagagerummet.
2. Løsn minuskablet på 12/48-voltsbatteriet ved skrueforbindelsen, og sikr det mod utilsigtet kontakt.



De passive sikkerhedssystemer (airbags og forspændere til sikkerhedssele) deaktiveres.



#### 4. Adgangveje til tilskadekommande

Ved frigørelse af personerne i bilen skal der tages hensyn til komponenterne i sikkerhedssystemerne (især pyrotekniske elementer) i overensstemmelse med angivelserne på side 1.



Ratindstilling



Sædeindstilling (elektrisk)



Ratindstilling



Sædeindstilling (elektrisk)

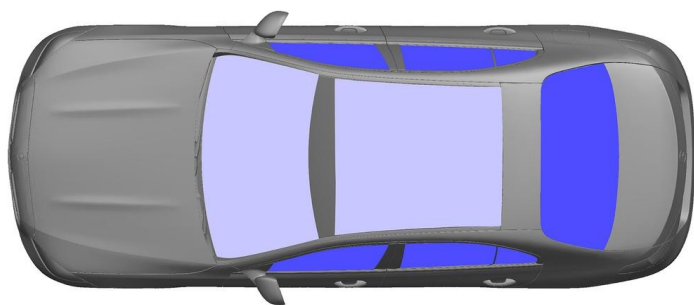

VSG: lamineret sikkerhedsglas  
ESG: hærdet glas

#### 5. Oplagret energi / væsker / gasser / faste stoffer



#### 6. I tilfælde af brand



Brug store mængder vand (H<sub>2</sub>O), når en køretøjsbrand skal slukkes.

#### 7. I vand

Der er ingen fare ved, at der er spænding på karrosseriet. Efter bjærgning af køretøjet:

1. Lad vandet løbe ud af kabinen.
2. Påbegynd deaktivering af 12-/48-voltsledningsnettet (se kapitel 3).

#### 8. Bugsering / transport / opbevaring

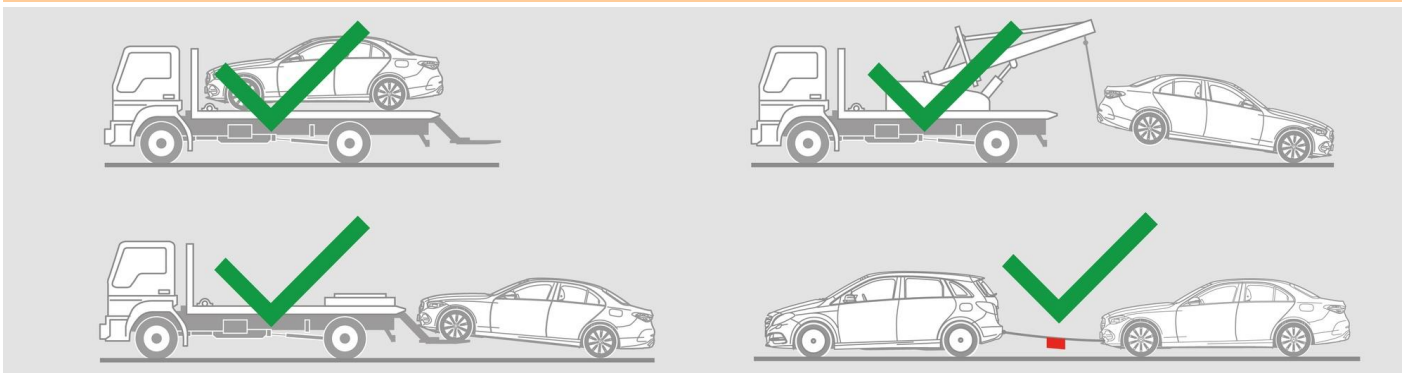



## 9. Vigtige ekstra oplysninger

Yderligere oplysninger findes i [Vejledning for bjærgningsfirmaer, personvogne](#).

## 10. Piktogram information



Køretøj på brændstof i klasse 1



Generelt advarsskilt



Brandfarligt



Farligt for menneskers sundhed



Ætsende



Akut toksicitet



Brug vand til at slukke ilden



Brug tørt skum til at slukke ilden



Brug vådt skum til at slukke ilden



Motorhjelm



Bagagerum



Fjern smart nøgle