













- |   |                                 |   |  |   |   |   |                 |   |                                     |
|---|---------------------------------|---|--|---|---|---|-----------------|---|-------------------------------------|
|  | Kollisjonspute                  |  | Gassgenerator                                      |  | Beltestrammer   |  | SRS styreenhet  |  | Aktivt fotgjengerbeskyttelsessystem |
|  | Gasstrykkdemper / Forspent fjær |  | Lavvolt-batteri                                    |  | Diesel drivstofftank  |  | Høyvolt-batteri |  | Høyvolt-kabel                       |
|   | Høyvolt-komponenter             |  | Alternativ innretning for utkobling av høyspenning |   |  | Høyspenningsskillepunkt (lavspenningselement)                                       |                 |   |                                     |

Merknad: Mer informasjon finner du i vår [bergingsveiledning](#).



### 1. Identifisering / Gjennkjenning

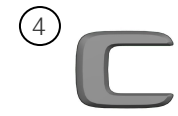
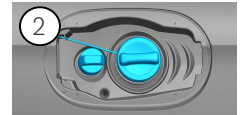
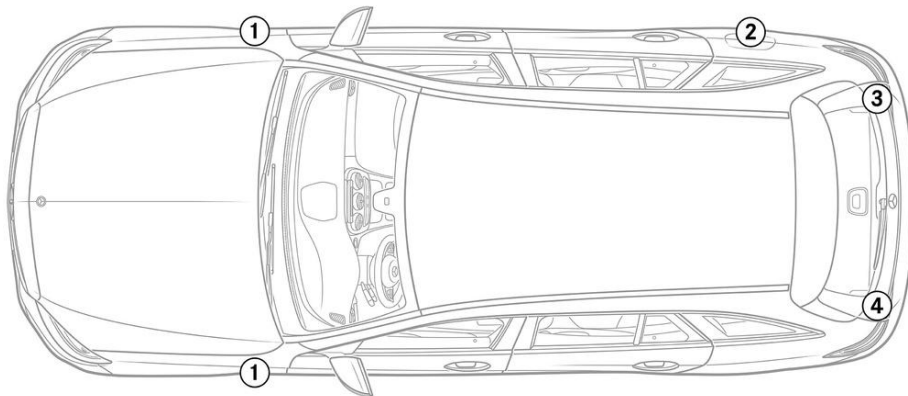

### 3. Deaktivere direkte farer / sikkerhets regler

#### Deaktivere høyspenningssystemet

I alle andre tilfeller skal høyspenningssystemet deaktiveres som følger:

#### Alternativ 1: Innretning for utkobling av høyspenning

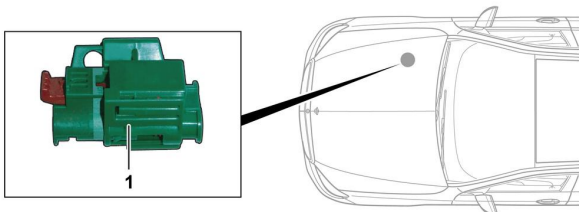

Innretningen for utkobling av høyspenning er plassert i motorrommet på passasjersiden.



- (1) Trekk i opplåsingsspaken
- (2) Trykk opplåsingsspaken nedover
- (3) Trekk ut bryteren

#### Alternativ 2: Alternativ innretning for utkobling av høyspenning



Den alternative innretningen for utkobling av høyspenning er plassert under dekselet til sikringsboksen på cockpiten på førersiden. Den er merket med et henvisningsskilt.

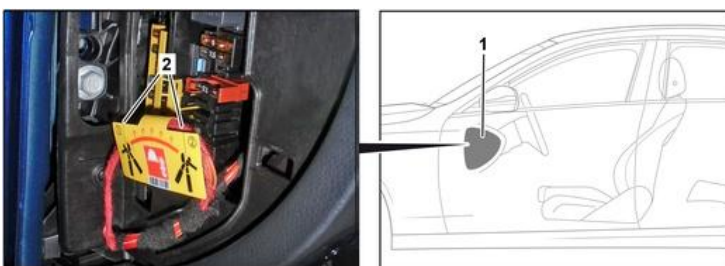

Fjern deksel (1) Kutt opp på markert punkt (2).



#### Klem av 12-V-batteriet

1. Fjern dekselet på 12-V-batteriet.
2. Løsne skruforbindelsen på minuskabelen til 12-V-batteriet, og sikre mot utilsiktet kontakt.