







① Linkslenker

② Rechtslenker

-  Airbag
-  Gasgenerator
-  Gurtstraffer
-  SRS Steuergerät
-  Gasdruckdämpfer / vorgespannte Feder
-  Niedervolt-Batterie
-  Benzin Treibstoff-tank

Hinweis: Weiterführende Informationen entnehmen Sie bitte unserem [Rettungsleitfaden](#).



1. Identifizierung / Erkennung

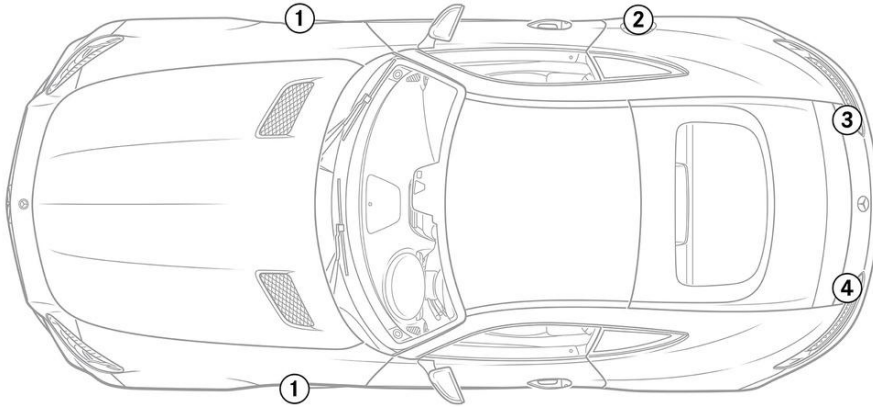

1

V8 BITURBO

2

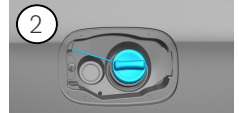

3

GT

4

