







-  Airbag
-  Generatore di gas
-  Pretensionatore delle cinture di sicurezza
-  Scheda elettronica SRS
-  Ammortizzatore pneumatico / molla precaricata
-  Batteria a basso voltaggio
-  Diesel serbatoio del carburante

Nota: Ulteriori informazioni sono disponibili nelle nostre linee guida per il soccorso [linee guida per il soccorso](#)



## 1. Identificazione / riconoscimento



## 2. Immobilizzazione / stabilizzazione / sollevamento

### Freno di parcheggio

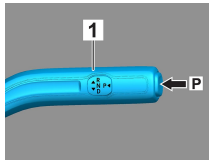

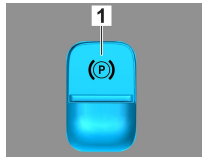
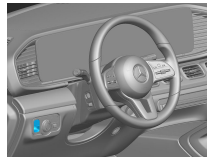

### Freno di stazionamento

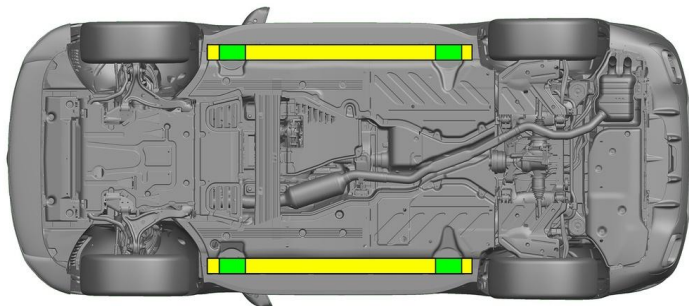

Premere il pulsante P sulla leva di selezione (1). Il freno di stazionamento elettrico (1) viene attivato automaticamente.



-  Adeguati punti di sollevamento
-  Adeguati punti di stabilizzazione sul lato



Evitare un'ulteriore deformazione della pedana e del sottoscocca durante il salvataggio (ad es. sollevamento con equipaggiamento idraulico).



### 3. Disattivazione dei pericoli diretti / Regolamenti di Sicurezza

#### Disinserire l'accensione:

1. Premere il tasto START-STOP senza azionare il freno di esercizio.
2. Tenere la chiave elettronica del veicolo a distanza di almeno 5 m.

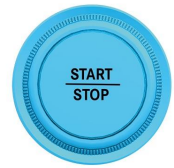

L'assenza di rumori dal motore non significa che il veicolo sia spento.



Un riavvio è possibile solo fino alla messa fuori servizio del veicolo.



#### Scollegare la batteria a 12 V

1. Rimuovere il coperchio della batteria a 12 Volt.
2. Scollegare il cavo negativo della batteria a 12 Volt nel raccordo a vite e metterlo in sicurezza contro un involontario contatto.



I sistemi di sicurezza passivi (airbag e pretensionatori delle cinture di sicurezza) vengono disattivati.

### 4. Accesso agli occupanti

Nell'ambito della liberazione degli occupanti si deve tenere conto dei componenti dei sistemi di ritenuta (in particolare degli elementi pirotecnici) conformemente alle indicazioni fornite a pagina 1.

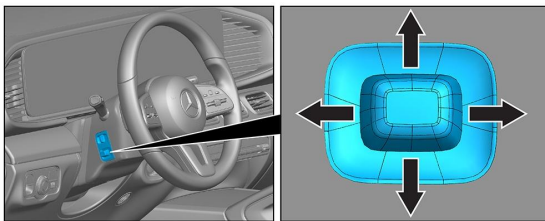

Regolazione del volante

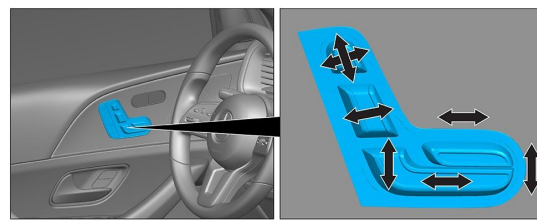

Regolazione (elettrica) del sedile

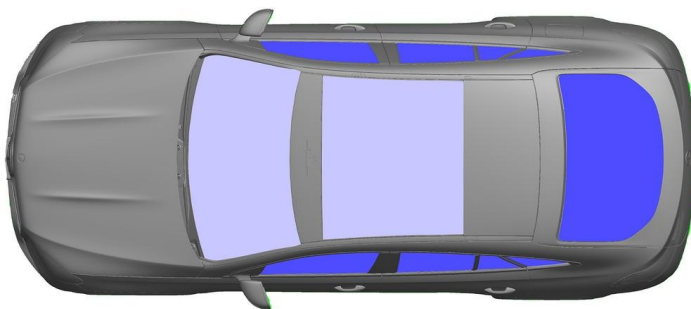

- VSG: Verbundsicherheitsglas, vetro stratificato di sicurezza
- ESG: vetro di sicurezza monostrato

### 5. Immagazzinamento energia / liquidi / gas / solidi



### 6. In caso d'incendio



Per estinguere l'incendio di un veicolo utilizzare grandi quantità di acqua (H<sub>2</sub>O).

### 7. In caso di immersione

Non sussiste il pericolo di tensione sulla carrozzeria. Dopo il recupero del veicolo:

1. Fare defluire l'acqua dall'abitacolo.
2. Avviare la disattivazione della rete di bordo a 12/48 V (vedere il capitolo 3).





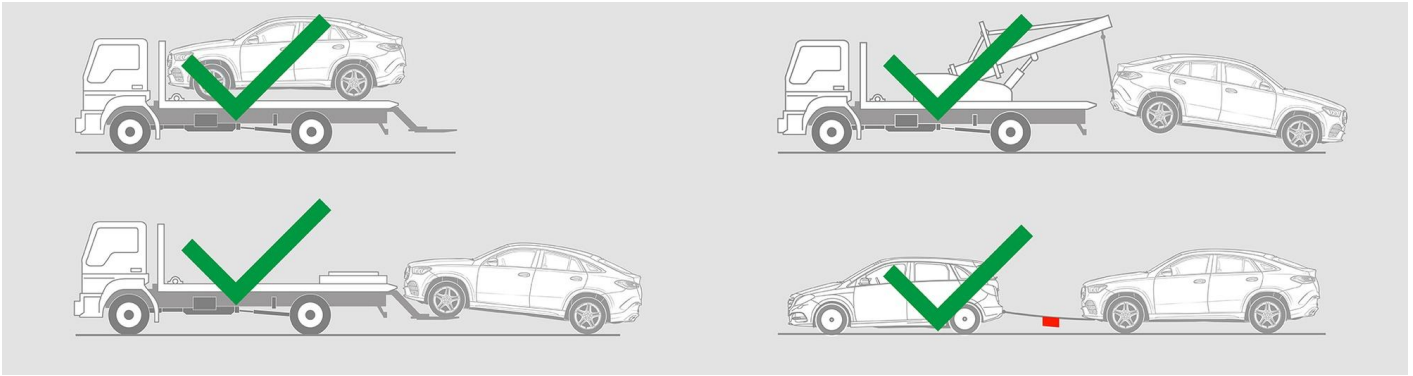







### 8. Traino / trasporto / stazionamento



### 9. Informazioni aggiuntive importanti

Ulteriori informazioni sono riportate nelle [Linee guida per i servizi di traino Autovetture](#).

### 10. Spiegazione dei pittogrammi utilizzati

- |   |  |   |                               |   |  |   |  |
|---|--|---|-------------------------------|---|--|---|--|
|     | Veicolo con carburante del gruppo liquido 1        |    | Attenzione pericolo generico  |  | Infiammabile                               |  | Pericoloso per la salute umana                     |
|     | Corrosivi  |    | Tossicità acuta               |  | Utilizzare l'acqua per spegnere l'incendio |  | Utilizzare schiuma a secco per spegnere l'incendio |
|  | Utilizzare schiuma bagnata per spegnere l'incendio |  | Rimozione chiave intelligente |   |  |   |  |