

-  에어백
-  가스 발전기
-  안전벨트 텐서너
-  SRS 컨트롤 유닛
-  가스 압력 댐퍼/프리텐션 스프링
-  저전압 배터리
-  디젤 연료 탱크
-  고전압 배터리
-  고전압 케이블
-  고전압 콤포넌트
-  대체 고전압 분리 장치
-  고전압 분리 지점 (저전압 요소)

참고 사항: 자세한 내용은 [구조 안내서](#) 참조.

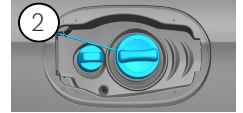

### 1. 식별/인식

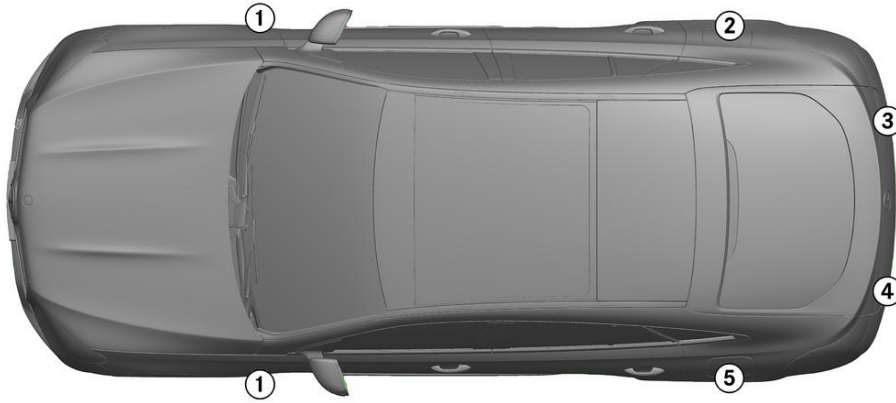

### 2. 고정 / 안정화 / 리프팅

#### 주차 브레이크

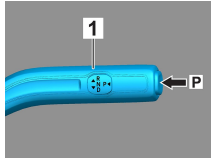

#### 주차 브레이크

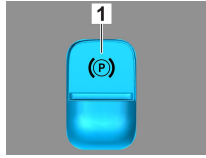
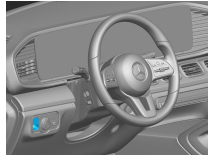

선택기 레버(1)의 스위치 P를 누르십시오. 주차 브레이크가 자동으로 활성화됩니다.

전자 주차 브레이크 (1)

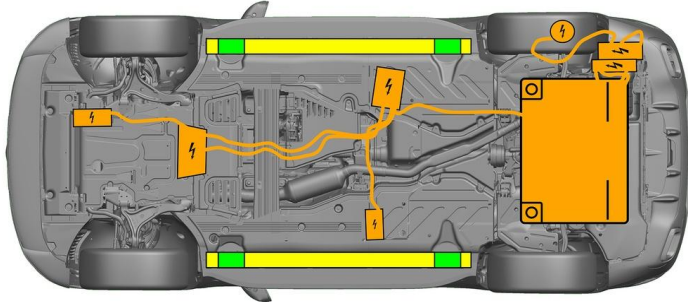

- 적합한 인양 지점
- 측면의 적합한 안정화 지점
- 고전압 배터리



구조하는 중 로커 패널과 언더바디의 추가적인 변형(예: 유압 장비로 지지)이 없도록 유의해야 합니다.

### 3. 직접적인 위험 제거 / 안전 규정 준수

#### 점화 장치 끄기:

- 주 브레이크를 밟지 않은 상태에서 START-STOP 버튼을 누르십시오.
- 전자 차량 키를 5m 이상의 거리에 두십시오.



엔진 소음이 없다고 해서 차량이 꺼져 있는 것은 아닙니다.



차량이 종료될 때까지 재시동이 가능합니다.

#### 고전압 시스템 비활성화



에어백과 안전벨트 텐서너를 작동시키는 사고가 발생할 경우 고전압 시스템이 자동으로 꺼집니다.





다른 모든 경우에는 다음과 같이 고전압 시스템을 비활성화해야 합니다.

### 옵션 1: 고압 분리 장치

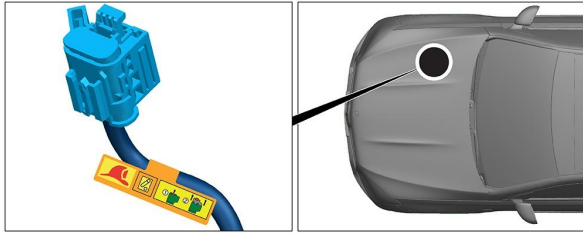

고전압 분리 장치는 동반석 측 엔진실에 있습니다.

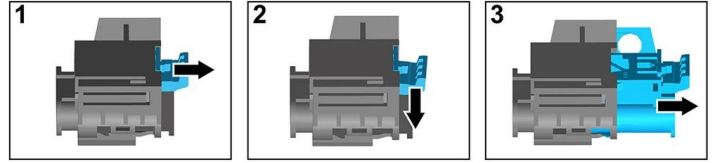

- (1) 해제 레버 당기기
- (2) 해제 레버 아래로 누르기
- (3) 스위치 밖으로 빼내기

### 옵션 2: 대체 고압 분리 장치

대체 고전압 분리 장치는 운전석 측의 콕핏 퓨즈 상자 커버 아래에 있습니다. 이 장치는 정보 라벨로 표시되어 있습니다.

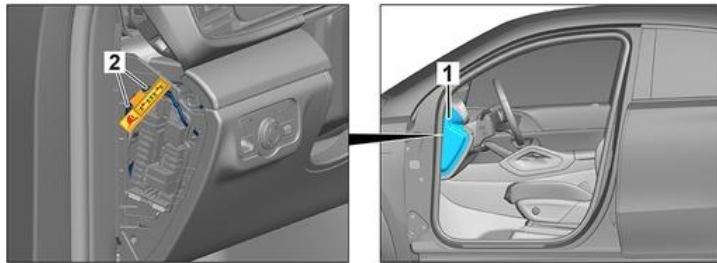

커버(1)를 제거하십시오. 표시된 지점(2)에서 라인을 절단하십시오.



고전압 네트워크에 잔류 전압이 없는지 확인하려면 스위치를 끈 후 약 20초 동안 기다리십시오.



에어백 및 안전벨트 텐서와 같은 수동 보안 시스템은 12V 차량 전원 시스템에 의해 계속해서 전원이 공급됩니다.



### 12V 배터리 분리

1. 12V 배터리 커버 제거.
2. 12V 배터리의 음극 케이블을 볼트 체결부에서 푼 후 의도치 않게 접촉되지 않도록 보호하십시오.



수동 보안 시스템(에어백 및 안전벨트 텐서)이 비활성화됩니다.



#### 4. 요구조자(탑승자)에 접근

승객을 구조할 때 페이지 1의 정보에 따른 시트 안전 시스템의 부품(특히 폭발 요소)을 고려해야 합니다.

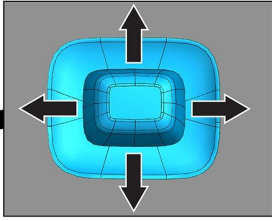
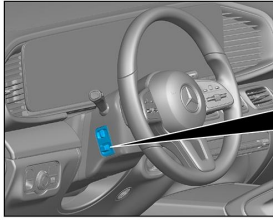

스티어링 휠 조정

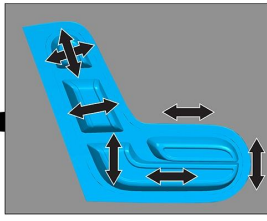
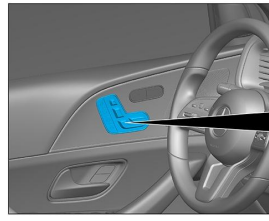

시트 조정(전동식)

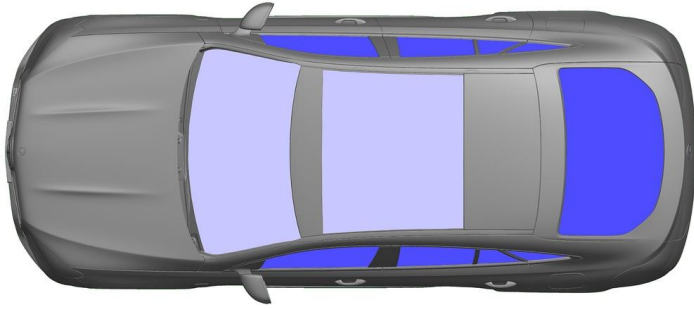

VSG: 접합안전유리

ESG: 강화 안전 유리

#### 5. 저장된 에너지/액체/가스/고체



모든 고전압 라인은 주황색 절연재와 함께 제공됩니다.

#### 6. 화재 시



차량 화재를 진압하려면 다량의 물(H<sub>2</sub>O)을 사용하십시오.  
리튬 이온 배터리를 냉각하려면 다량의 물(H<sub>2</sub>O)을 사용하십시오.



경고: 배터리의 재점화



고전압 배터리에서 냉각수가 누출되면 열 과부하로 인해 고전압 배터리가 불안정해질 수 있습니다. IR 열 화상 카메라로 배터리 온도를 점검하십시오.



#### 7. 침수 시

차체에 전압이 남아 있을 위험이 없습니다.

차량 구조 후:

1. 내부의 물을 배출시키십시오.
2. 고전압 시스템의 비활성화를 시작하십시오(3장 참조).



### 8. 견인/운송/보관

차량의 두 차축으로만 견인 트럭이나 자동차 운반 수단에 올려 운반하십시오.

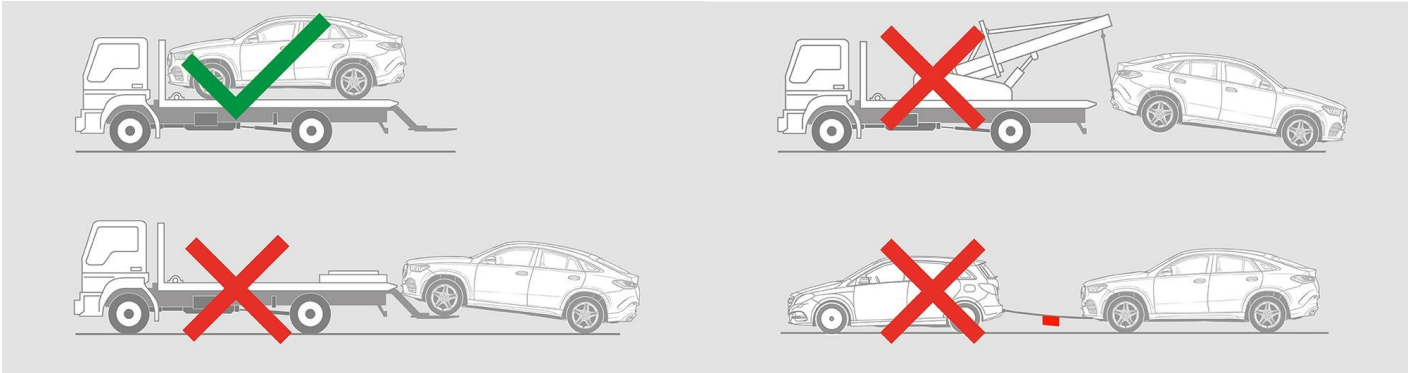

다른 차량과 안전한 거리를 유지하십시오.

 경고: 배터리의 재점화 

### 9. 중요 추가 정보

자세한 내용은 [견인 서비스 지침](#), [승용차](#) 에서 확인할 수 있습니다.

### 10. 사용된 픽토그램 설명

-  전기 하이브리드 차량, 1급 액체 연료 주입
-  위험
-  위험 전압
-  가연성
-  건강에 위험
-  부식성
-  만성 독성
-  물로 끄기
-  IR 열영상 카메라 사용
-  엔진 후드
-  스마트 키 제거