









- |   |   |  |  |   |
|---|---|--|--|---|
|  Kollisjonspute                  |  Gassgenerator   |  Beltestrammer        |  SRS styreenhet |  Aktivt fotgjengerbeskyttelsessystem |
|  Gasstrykkdemper / Forspent fjær |  Lavvolt-batteri |  Bensin drivstofftank |  |   |

Merknad: Mer informasjon finner du i vår [bergingsveiledning](#).



### 1. Identifisering / Gjenkjenning



CLA 220

### 2. Immobilisering / stabilisering / løfting

#### Parkeringsbrems



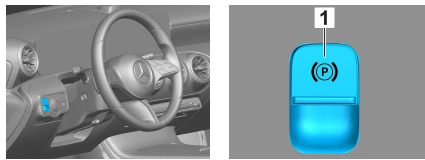

Trykk på bryter P på girvelgeren (1).  
Parkeringsbremsen aktiveres automatisk.

#### Håndbrems

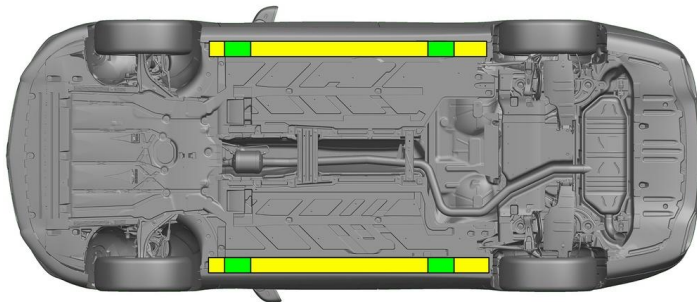

Elektrisk håndbrems (1)



-  Eget løftepunkt
-  Eget stabilisering på siden



En ekstra misforming av travers og underrammen må unngås under bergingen (f.eks. gjennom å støtte med hydraulikkutstyr).

### 3. Deaktivere direkte farer / sikkerhets regler

#### Slå tenningen av:

1. Trykk på START-STOPP-knappen, uten å aktivere motorbremsen.
2. Oppbevar den elektroniske bilnøkkelen i en avstand på minst 5 m.



Selv om du ikke kan høre om motoren går, betyr ikke dette at bilen er slått av.



Bilen kan starte på nytt, helt til den settes ut av drift.



#### Klem av 12-V-batteriet

1. Fjern dekselet på 12-V-batteriet.
2. Løsne skruforbindelsen på minuskabelen til 12-V-batteriet, og sikre mot utilsiktet kontakt.



De passive sikkerhetssystemene (airbagger og beltestrammere) deaktiveres.



### 4. Tilgang til fører/passasjerer

Under redningen av personene i bilen skal man ta hensyn til komponentene til passasjersikringssystemet (spesielt pyrotekniske elementer) i henhold til opplysningene på side 1.



Rattinnstilling





Seteinntstilling (mekanisk)



Seteinntstilling (elektrisk)



 VSG: Laminert sikkerhetsglass

 ESG: Herdet sikkerhetsglass

### 5. Lagret energi / væske / gass / fast



### 6. I tilfelle brann



Bruk store mengder vann (H<sub>2</sub>O) når du slukker en bilbrann.

### 7. I tilfelle nedsenket i vann/sjø

Det foreligger ikke fare for at spenningen går over på karosseriet. Etter at bilen er berget:

1. Slipp ut vannet fra bilens innside.
2. Begynn med å deaktivere 12-V/48-V-ledningsnett (se kapittel 3).

### 8. Tauing / transport / lagring





## 9. Viktig ekstra informasjon

Mer informasjon finner du i [Veiledning for slepetjenester for sleping av personbil](#).

## 10. Forklaring av piktogrammer



Kjøretøy med flytende drivstoff kl. 2



Fare



Brennbar



Helsefarlig



Korroderende



Akutt toksisitet



Slukke med vann



Slukkes med tørt skum



Slukkes med vått skum



Panser



Fjern smartnøkkel