







12V
AGM

-  Airbag
-  Gerador de gás
-  Pré-tensor do cinto de segurança
-  Unidade de controlo SRS
-  Mola de pressão a gás/mola pré-tensionada
-  Bateria de baixa voltagem
-  Diesel reservatório de combustível

Indicação: Para mais informações, por favor consulte o nosso [guia de salvamento](#).



1. Identificação / reconhecimento



2

VITO

3

110 CDI

4

114 CDI

5

116 CDI

6

119 CDI

2. Imobilização / estabilização / levantamento

Travão de estacionamento

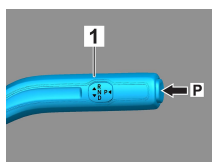

Travão de estacionamento

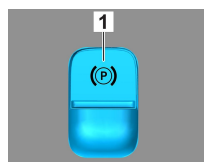

Premir a alavanca de seleção (1) na posição P. O travão de estacionamento é ativado automaticamente.

Travão de estacionamento elétrico (1)

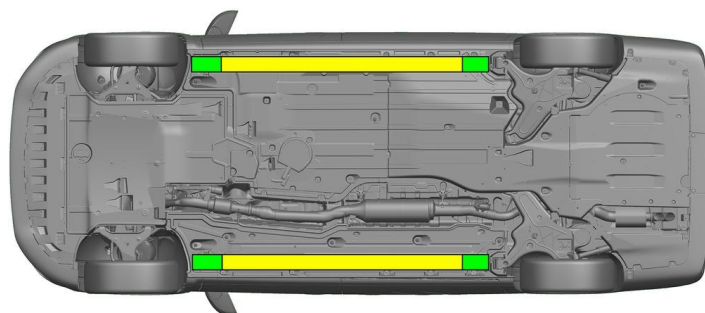

Pontos de elevação adequados



Pontos de estabilização adequados no lado



Deve ser evitada uma deformação adicional das soleiras e da estrutura de suporte do piso durante o salvamento (p. ex., através de apoio com equipamento hidráulico).

3. Neutralização dos principais perigos / regras de segurança

Desligar a ignição:

1. Pressionar a tecla START-STOP sem acionar o travão de serviço.
2. Manter as chaves eletrónicas do veículo a pelo menos 5 m de distância.

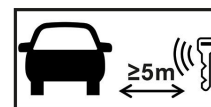

A ausência de sons do motor não significa que o veículo esteja desligado.



Um reinício é possível até o veículo ser retirado de serviço.



Desconectar a bateria de 12 V

1. Retirar a cobertura das baterias de 12 volts.
2. Soltar o cabo negativo da bateria de 12 volts na união roscada e proteger contra contacto involuntário.



Os sistemas de segurança passivos (airbags e pré-tensores de cintos de segurança) são desativados.



4. Acesso aos ocupantes

Os componentes dos sistemas de retenção (particularmente os elementos pirotécnicos) devem ser tidos em consideração quando os ocupantes saírem do veículo, de acordo com as indicações na página 1.

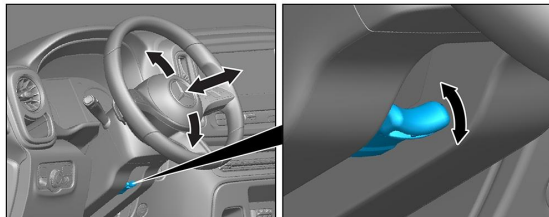

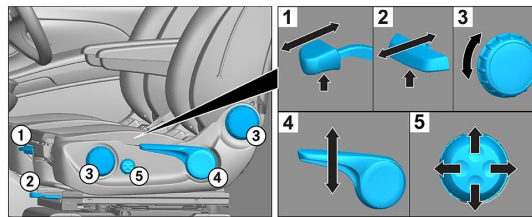

Ajuste do volante







Ajuste do assento (mecânico)

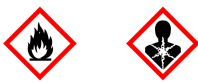

 VSG: vidro de segurança laminado
 ESG: vidro de segurança temperado

5. Armazenamento de energia / líquidos / gases / sólidos

		12V
		70L
		600 ± 10g

6. Em caso de incêndio



Utilizar grandes quantidades de água (H₂O) para extinguir um incêndio num veículo.

7. Em caso de submersão

Não há perigo de ser aplicada tensão à carroçaria. Após o resgate do veículo:

1. Deixar escoar a água do interior.
2. Iniciar a desativação da rede de bordo de 12/48 V (ver capítulo 3).

8. Reboque / transporte / estacionamento

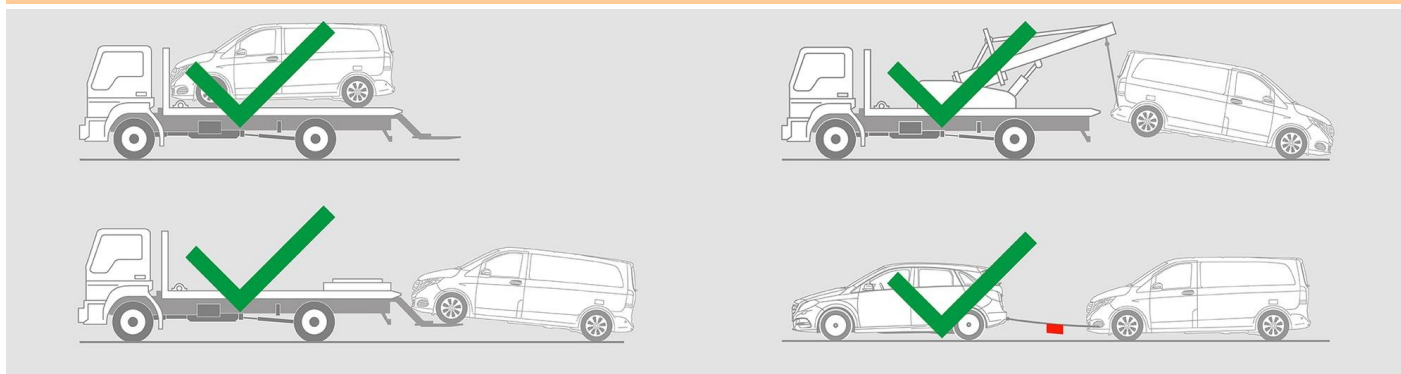



9. Informação adicional importante

Para mais informações, veja o [Guia para serviços de reboque para veículo de passageiros](#).

10. Explicação dos pictogramas usados



Veículo a combustível do grupo 1



Advertência geral



Inflamável



Perigoso para a saúde humana



Corrosivo



Explosivo



Usar água para extinguir o fogo



Usar espuma seca para extinguir o fogo



Remover smart key



Componente de ar-condicionado



Cuidado; baixa temperatura